

BC

SoundExtreme Elite[®] 18 inch Powersports Amplified Soundbar

SE18E



Model: SEI-SE18E01AU

User Guide

Introduction

Features

The SoundExtreme Elite (referred to as SE18E) includes the following features.

Speaker with Big Sound

- 300 watt peak power.
- 5 Marine-grade speakers: 1 tweeter, 2 mid-ranges, 2 woofers.

Multi-Audio Source Inputs and Output

- Bluetooth streaming.
 - Bluetooth 5.1 long range and reliable connection to your phone.
 - Dual simultaneous connections – switch playback between two phones.
 - Built-in speakerphone function.
- FM radio (no AM radio).
- Aux-In / Aux-Out.

Built-in EcoCast Wireless Audio

- Wirelessly stream your radio's Bluetooth music, FM radio and Aux-In audio to EcoCast-enabled speakers. Supports up to 100 wireless connections between any mix of EcoCast-enabled ECOXGEAR and SoundExtreme soundbars, subwoofers, radios, and party speakers.
- Play audio streams wirelessly received from an EcoCast Transmitting speaker. No wires!

Built-in LEDCast 2-Zone LED Controller

- 1 Zone for LED backlit speakers on the front and sides of the soundbar.
- 1 Zone for the rear-facing LED Light Bar.

Integrated Addressable RGB LED Lights

- Addressable RGB LED backlights on the 2 mid-range speakers and 2 woofers.
- Dual-function rear-facing light bar – RGB party lights and utility (white) light with 3 brightness settings.

Includes SoundExtreme RF Universal Remote Control

- Control the core audio and lighting functions remotely anywhere near and around your vehicle.

SoundExtreme Smartphone App

- With the free SoundExtreme Smartphone App customize your LED's colors, speed, brightness, music sync and LED chasing. Create custom scenes to change all Zones at once with your favorite LED light show. Add additional 4-Zone LED controllers (sold separately) and other LEDCast products to expand your light show. Control them all from one app!

5V USB Charge Out

- A 5V, 2.1A USB charge output for charging your phone.

Mounting Options

- End-cap mounting brackets and integrated mounting rail with threaded mounting holes for multiple mounting configuration options.
- Check out www.soundextreme.com.au for additional mounting bracket options.

Introduction

Important

- Please read the User Guide before installation and use.
- Your SoundExtreme Elite soundbar (referred to as SE18E) requires a 12V DC voltage power input. If your vehicle battery power output is not 12V (e.g., 24V, 36V, or 48V), you will need a voltage converter with 12V output (e.g., a 48V-to-12V converter). Connecting the SE18E directly to higher voltages will cause damage to the soundbar and **VOID THE PRODUCT WARRANTY**.
- The SE18E is compatible with the ECOXGEAR audio and LED lighting EcoSystem, which includes LEDCast and EcoCast Innovations. Look for the LEDCast and EcoCast logos on the growing family of ECOXGEAR and SoundExtreme audio and lighting solutions. EcoCast-enabled audio products are designed to be paired with one or more EcoCast-enabled products. Simply initiate EcoCast Transmitting Mode in one SoundExtreme or ECOXGEAR speaker and broadcast your music to one or more EcoCast-enabled products in Receiving Mode.
- Each time you provide power to your SE18E, the speaker will enter the Power State that the speaker was in before power was removed – the soundbar will either turn off (Standby Mode) or turn on – i.e., the speaker functions similarly to your car radio. The SE18E has 3 power states: Power On, Standby, and Power Off. The Power State functionality depends on whether the SE18E is directly connected to a vehicle's 12V battery or through a switch (the SE18E connects to a switch, and the switch connects to the 12V battery):
 - If your SE18E is directly connected to a vehicle's 12V battery, pressing the Power Button  on the speaker or on the Remote Control will turn on the speaker or turn off the speaker (i.e. put speaker into Standby Mode where the speaker consumes minimal power). As the SE18E keeps a power connection to the 12V battery, this scenario does **NOT** have a complete power off state.

- If the SE18E is connected to a vehicle's 12V battery through a switch, there are two scenarios:
 - i. If the switch is turned off, the SE18E is powered off.
 - ii. If the switch is on, pressing the Power Button on the speaker or on the Remote Control will turn on the speaker or put the speaker into Standby Mode.
- LED lights are known to create interference (noise) on some FM radio frequencies (stations). When you tune or seek a station, it is recommended that you turn the LED Party Lights off.
- **CAUTION:** After taking the product out of the polyethylene bag, be sure to dispose of the polyethylene bag out of the reach of children. Children may play with the bag, which could result in the child's suffocation.



WARNING: REMOTE CONTROL INCLUDES A BUTTON BATTERY



Keep the **BUTTON BATTERY** out of reach of **CHILDREN**.

If you suspect your child has swallowed or inserted a button battery, call the Poisons Information Centre immediately on 13 11 26 for 24/7 fast, expert advice.



If your child is having any difficulty breathing, contact 000. As it may lead to serious injury, chemical burns or death in 2hrs or less.

SE18E SoundExtreme Elite Overview

SE18E Layout

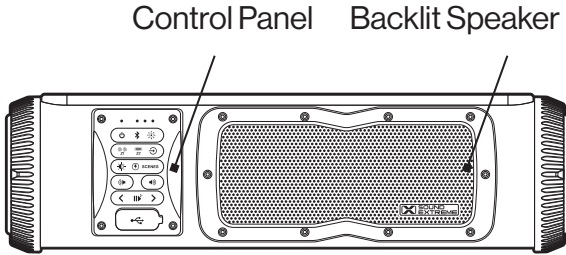

FRONT

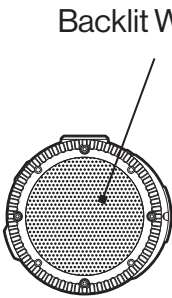

LEFT SIDE

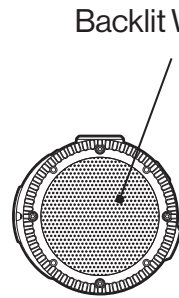

RIGHT SIDE

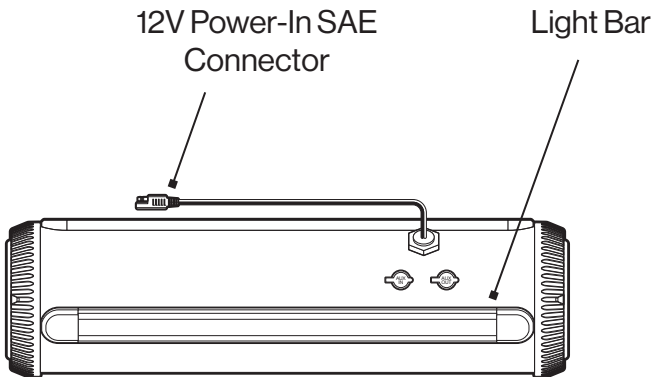

BACK

SE18E SoundExtreme Elite Overview

Inputs and Outputs

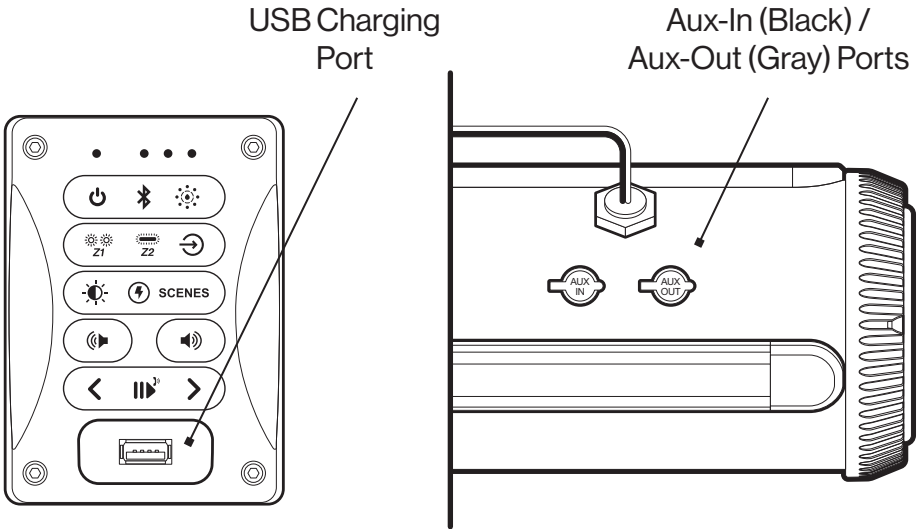

Do **NOT** use these connections if the connections are wet.

Power Input: SAE connector. +12VDC input only. 15A maximum.

Aux-In: 3.5mm audio jack. This input can be used to connect an additional soundbar, CD player, MP3 player, etc.

Aux-Out: 3.5mm audio jack. This output can be used to connect to an additional soundbar, radio, amplifier, or to any audio system with an Aux-In connection.

USB Charging Port: USB A jack. This output can be used to charge your smartphone or other devices. USB charging only functions when the speaker's power is turned on. USB port rating is 5V, 2.1A.

IMPORTANT: Maintaining Waterproofness

When not in use, if the caps on the USB Charging Port, the Aux-In Jack, or the Aux-Out Jack are not properly closed, the unit is **NOT** watertight. To close them properly, push firmly to be sure the caps fit flat along their edges.

SE18E SoundExtreme Elite Overview

Speaker LEDs, Light Bar, and Utility Light

The SE18E soundbar has an integrated LEDCast lighting controller to support the built-in addressable LED Party Lights and Utility Light on the soundbar. The LED Party Lights driven by the integrated controller provide millions of Color Modes: solid colors, fading, jumping, chasing, speed, and variable brightness.

- There are RGB LED Party Lights behind the 2 mid-range Speakers on the front, the 2 Woofers on each side, and the rear-facing LED Light Bar.
- Additionally, the rear-facing Light Bar can also be used as a white Utility Light, which provides 3 levels of brightness: high, mid, and low.

Note: The RGB LED Light Bar and Utility Light are co-located on the same Light Bar on the back; as such, the Light Bar cannot function as a white Utility Light and RGB LED Party Lights at the same time. Refer to **Light Bar: Utility Light and Zone 2 RGB LED Party Lights** for more details.

Buttons and LED Status Indicators

1. **LED Indicators:** The first 3 LEDs correspond to different functions: Power, Bluetooth, and Mode.

i. Power

- Solid Green: Power On
- No Light: Power Off or Standby

ii. Bluetooth

- Flashing Blue: Bluetooth Pairing
- Solid Blue: Bluetooth Connected

iii. Mode

- Solid Blue: Speaker Mode (EcoCast is turned off)
- Flashing Red: EcoCast Transmitting Mode – Pairing Ready
- Solid Red: EcoCast Transmitting Mode
- Flashing Green: EcoCast Receiving Mode – Pairing Ready
- Solid Green: EcoCast Receiving Mode – Paired with EcoCast Transmitting speaker
- Solid Yellow: FM Mode
- Solid Purple: Aux-In

2. **Power Button:** 

- Short-press to turn the soundbar on / put into Standby.
- **Press and hold** for 3 seconds to turn both LED Zones on / off.

3. **Bluetooth Button:** 

- When in Bluetooth Mode, if the Bluetooth LED Indicator is not flashing Blue, press this button to enter Bluetooth Pairing. If

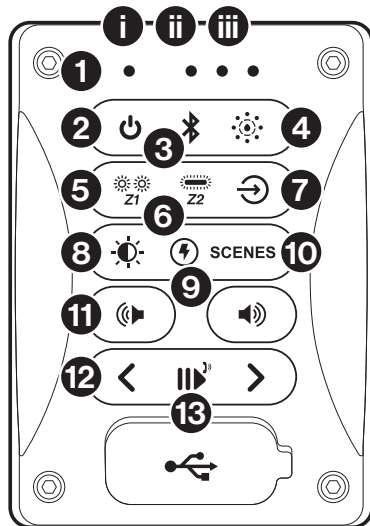

SE18E SoundExtreme Elite Overview

your device is connected (solid Blue LED), press the button to disconnect and re-enable pairing.

- **Press and hold** for 5 seconds to clear all pairing memory.

4. EcoCast Button:

- Short-press to enable EcoCast pairing.
- **Press and hold** for 5 seconds to clear the EcoCast pairing memory.

5. Zone 1 Button: Z1 – LED Party Lights on Backlit Speakers

- Short-press to turn on the LED Party Lights behind the speakers.
- When the lights are on, short-press to cycle through each of the 45 LED Button Modes. There are a total of 44 LED Lighting Modes supported by the Control Panel. (The SoundExtreme app can support many more Color Modes.) The 45th LED Button Mode is Off Mode. Therefore, a short-press on the 44th Mode will turn the lights off, and another short-press will cycle back to the first LED Lighting Mode again.
- When the lights are on, **press and hold** to turn off.





6. Zone 2 Button: Z2 – Light Bar

- Short-press to turn on the LED Light Bar on the back of the soundbar. When the lights are on, short-press to cycle through each of the 45 LED Button Modes.
- When the lights are on, **press and hold** to turn off.

7. Audio Mode Button: Press button to cycle through the following Audio Modes – Bluetooth, EcoCast Transmitting, EcoCast Receiving, FM, and Aux-In.

8. Brightness Button: Short-press to cycle through 5 levels of brightness.

SE18E SoundExtreme Elite Overview

9. **Speed Button:**  Short-press to cycle through 5 levels of speed. The lighting patterns, as defined by the selected LED Lighting Mode, will progress more quickly with each short-press.
10. **Scenes Button:**
- Short-press to cycle through all the 5 Scenes. (Scenes can only be programmed in the SoundExtreme Smartphone App).
 - **Press and hold** to turn on and turn off the rear-facing Utility Light.
11. **Volume Control Buttons:** 
- Press to adjust the speakers' volume.
 - **Press and hold** to adjust the volume continually.
12. **Track Buttons:**  
- In Bluetooth Mode, press buttons to play the previous / next track.
 - In FM Mode
 - Short press either button to tune to a radio station.
 - To “seek” (jump to the next available station), **Press and hold** either Button for a few seconds until it starts to seek a station.
13. **Play / Pause / Answer / EcoTalk Button:** 
- Press to play / pause a track or answer / end a mobile call from a paired Bluetooth phone.
 - EcoTalk: **Press and hold** to activate your Voice Assistant (Siri or Hey Google).

Installation and Wiring

Mounting Your Soundbar

1. To mount the speaker, first place the 2 Mounts on the ends of the SE18E soundbar at your desired orientation and attach them using three or four (depending on the orientation of your mount) Button Head Bolts, each. Tighten securely.
2. Ensure that the speaker fits in the desired location and mark where the mounts will be attached to your vehicle.
3. Drill holes at the desired mounting points on your vehicle, large enough for the provided $\frac{1}{4}$ -20 Bolts to fit.
4. Place the Rubber Feet on both Mounts.
5. Attach the Mounts to your vehicle with the provided $\frac{1}{4}$ -20 Bolts and Nuts. Tighten securely.

Tip: Alternatively to drilling holes into your vehicle, you can also use the provided Worm Clamps to secure the speaker to your vehicle. In order to prevent scratching /damage to your vehicle, slide the provided rubber sleeves onto the worm clamps before securing the speaker.

Note: For high-speed, high-vibration, and high-impact applications, we recommend using the provided $\frac{1}{4}$ -20 Bolt mounting solution, detailed above. Check out other mounting accessories at www.soundextreme.com.au

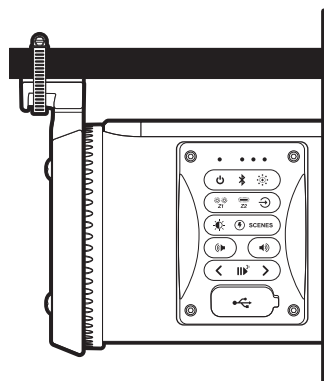
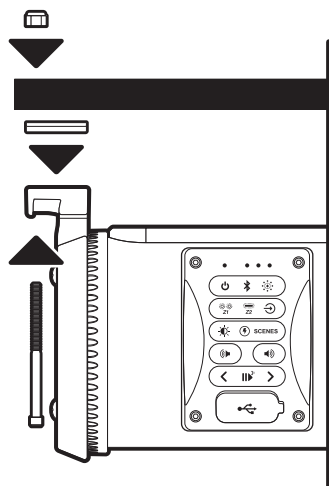
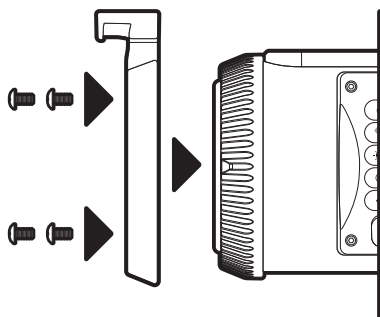

Connecting to 12V DC Power Supply

The SE18E does **NOT** have an internal battery. It **MUST** be connected to an external 12V DC power supply to function. When you install the SE18E to a battery or a voltage regulator on a golf cart, a boat, a quad bike, a UTV, or another vehicle, you need to make sure that your vehicle battery or battery pack terminal voltage is 12VDC. If the battery terminal voltage is not 12V, you will need a DC-DC converter with a 12V output and 15A capacity. Connecting the SE18E to a non-12VDC power source will lead to a malfunction or damage to the speaker.

WARNING: Even when powered off, the SE18E will continue to draw minimal power from your battery. To prevent draining your battery when your SE18E or powersports vehicle are not in use for more than 48 hours, unplug the SE18E from the battery or add a 15A toggle switch. (Toggle switch sold separately.)

Installation: 12V Power-In SAE Connector



1. Attach the 8ft Power Cable to the 12V Power-In SAE Connector.

Use Caution: Do **NOT** connect to 12V Battery if the Power-In SAE Connector is wet. Contact may cause electric shock and injury if wet.

2. Remove the 15 Amp Blade Fuse from the Fuse Holder.

Use Caution: Do **NOT** remove Fuse if the Fuse Holder is wet. An improperly fitted cap may cause electric shock and injury if wet.

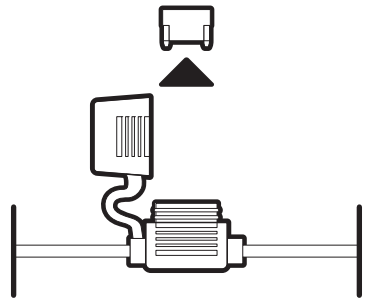

Installation and Wiring

3. To close properly, push firmly to be sure the cap snaps into place.
4. Next follow either the **Gas Vehicle** or **Electric Vehicle** Installation instructions.

Installation: Gas Vehicle

1. Loosen the bolts on the battery terminals.

Use Caution: Do **NOT** attempt to loosen bolts if battery is wet. Contact may cause electric shock and injury if wet.

2. Connect the **BLACK** wire to the **BLACK**, negative terminal, then the **RED** wire to the **RED**, positive terminal. Unit will not work correctly and may be damaged if wires are not correctly attached.
3. Tighten the bolts on the battery terminals until the connectors are held firmly in place.
4. Return the 15 Amp Blade Fuse into the Fuse Holder and close the cap.

Tip: Use zip ties to gather any excess wires, and secure them so that they are not dangling, loosely.

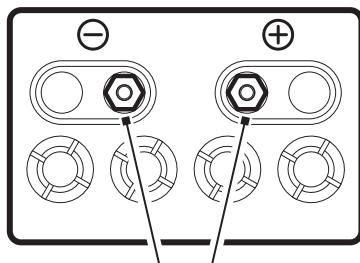

Loosen Bolts

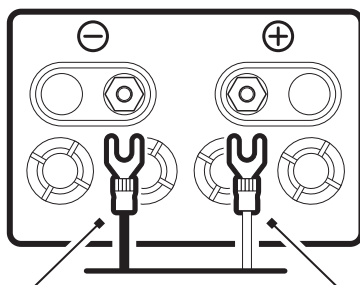

Black Cable Red Cable

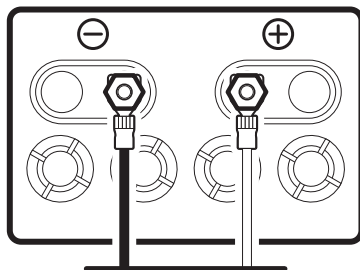

Tighten Bolts

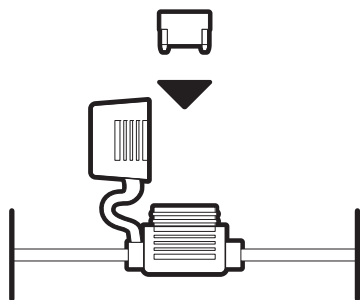

Installation: Electric Vehicle

1. Switch your vehicle to Tow mode, if available.
2. Wire the **BLACK** wire to the **GROUND** on output of the DC-DC Converter.
3. Wire the **RED** wire to the **POSITIVE (+)** post on the output of the DC-DC converter. Unit will not work correctly and may be damaged if wires are not correctly attached.
4. Return the 15 Amp Blade Fuse into the Fuse Holder and close the cap.

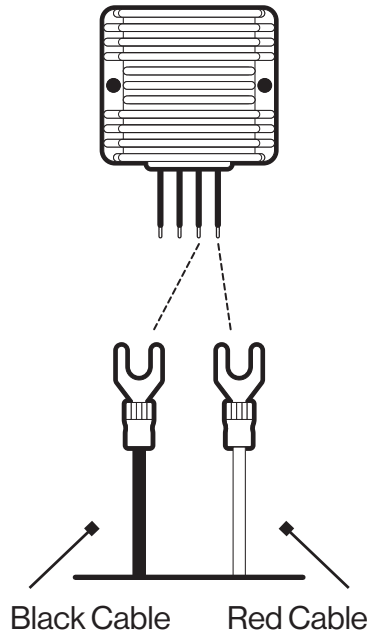

Use Caution: Do **NOT** connect to DC-DC converter if the 8ft Power Cable or the Power-In SAE Connector are wet. Contact may cause electric shock and injury if wet.

Tip: Use zip ties to gather any excess wires, and secure them so that they are not dangling, loosely.

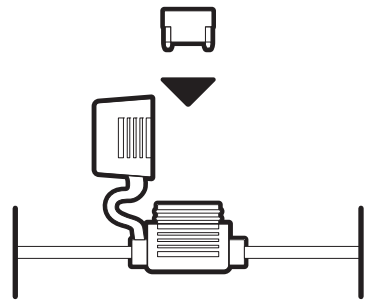

Aux-In Audio Connection

1. Gently pull out the rubber cover from the Aux-In Jack.
2. Plug in a 3.5mm audio cable (not included) into the audio output on the source unit.



Installation and Wiring

3. Plug in the other end of the 3.5mm audio cable into the SE18E soundbar's Aux-In Jack.
4. Short-press the Audio Mode Button  to cycle through to Aux-In Audio Mode.

Aux-Out Audio Connection



1. Gently pull out the rubber cover from the Aux-Out Jack.
2. Plug in a 3.5mm audio cable (not included) into the audio input on the external audio device.
3. Plug in the other end of the 3.5mm audio cable into the SE18E soundbar's Aux-Out Jack.

Connecting and Playing Bluetooth Audio

1. Press the Power Button  briefly to turn the speaker on.
2. Short-press the Audio Mode Button  to cycle through the Audio Modes until you hear, “Speaker Mode,” announced.
3. On your phone’s Bluetooth settings, select ‘**SoundEx-SE18**’ to pair. If you don’t see the speaker name, turn your phone’s Bluetooth off and back on again to refresh the list, or short-press the Bluetooth Button  on the speaker to enable Bluetooth Pairing again.
4. Wait for a few seconds. Once the pairing and connection are complete, the speaker will announce, “Your phone is connected,” and the Bluetooth LED Status Indicator will light up solid Blue.
5. Once connected, select and play your desired audio. You can now use the Play / Pause Button, Volume Control Buttons, or Track Buttons to control your audio.

Dual Simultaneous Connections and Switching Media Player Between Two Phones

Your SE18E is capable of maintaining simultaneous connections with two smartphones, which allows you and your family or friends to share music on the soundbar by switching the music playback between your phone and your family member or friend’s phone. Follow the steps outlined below to switch back and forth between two phones.

1. Connect your phone to the SE18E.
2. Short-press the Bluetooth Button  on the SE18E. This will disconnect your phone and enable Bluetooth pairing. Connect another phone to the SE18E.
3. Short-press the Power Button  on the SE18E. The speaker will turn off. Then short-press the button again to turn the speaker on.
4. Your SE18E will automatically reconnect to both phones.







Audio Functions

5. Play a selected music track on your phone. Your SE18E will play your music.
6. On the other phone, select a music track to play. Your SE18E will play the music from the other phone. The media player on your phone will pause or stop.
7. If you want to switch back to your phone, press the play button on your phone's media player, your SE18E will play the music on your phone. The media player on the other phone will pause or stop.

Listening to FM Radio

Recommendation: Turn the LED Party Lights off when searching for a radio station. LED lights can create interference with some FM radio frequencies.

Station Tuning

- Short-press the Audio Mode Button  to cycle through to FM Mode, the speaker will announce, "FM Mode."
- Short-press  or  to tune in a radio station.
- **Press and hold**  or  to seek a strong station.
- Short-press  or  to adjust the volume.

EcoCast – Stream Music Between Multiple Speakers



The SE18E has EcoCast built-in, which allows the soundbar to broadcast (transmit) or receive wireless audio streams to or from other EcoCast-enabled products.

EcoCast Streaming: Two Modes

Use the Audio Mode Button  to set the speaker into EcoCast Transmitting Mode or EcoCast Receiving Mode:

1. EcoCast Transmitting Mode: When set in this Mode, the EcoCast Transmitting speaker broadcasts audio to multiple wireless connected EcoCast-enabled speakers.

The Transmitting speaker's audio streaming can be the music played from your phone (via Bluetooth), FM Radio, or Aux-In Audio.

2. EcoCast Receiving Mode: When set in this Mode, the soundbar will receive audio from an EcoCast Transmitting speaker, soundbar, or radio.

Notes:

- When set to Speaker Mode, the Amplified Speaker turns the EcoCast capability off.
- When you have two or more soundbars or other ECOXGEAR or SoundExtreme speakers bearing the EcoCast symbol , you can build a broadcast system by initiating EcoCast Transmitting Mode in one soundbar and broadcasting your music to one or more EcoCast-enabled speakers in EcoCast Receiving Mode.

EcoCast: First Two Amplified Speakers

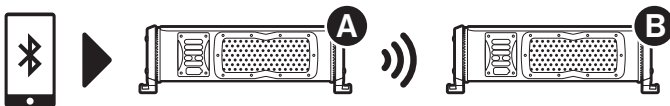

Follow the steps below to pair two SE18E speakers:



1. Follow the **Connecting and Playing Bluetooth Audio** instructions to connect one soundbar (**Speaker A**) to your Bluetooth device. After your device is connected to **Speaker A**, you can play your desired audio.

Audio Functions

2. Press the Audio Mode Button  to put **Speaker A** into EcoCast Transmitting Mode. The Mode LED Status Indicator will flash Red, and the speaker will announce, “EcoCast transmitting.”
3. Turn on the other soundbar (**Speaker B**) and press the Audio Mode Button to cycle through to and initiate EcoCast Receiving Mode. The Mode LED Status Indicator will flash Green, and the speaker will announce, “EcoCast receiving.”
4. Once the connection between the soundbars is successful, **Speaker B** will announce, “Connection successful,” and start playing audio.

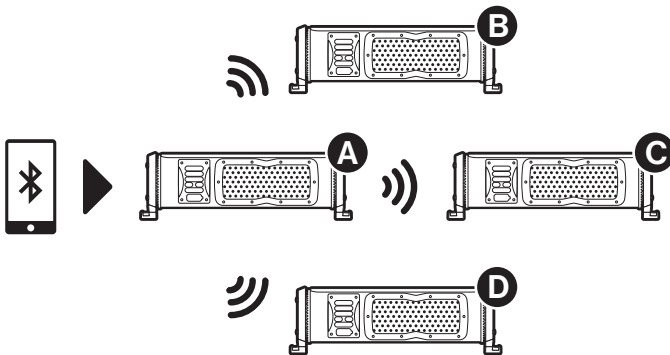
EcoCast: Additional Receiving Speakers



1. Turn on the additional EcoCast-enabled speakers (**Speaker C** and **Speaker D**) and press the Audio Mode Button  to cycle through to and initiate EcoCast Receiving Mode. The Mode LED Status Indicator will flash Green, and the speaker will announce, “EcoCast receiving.”
2. On **Speaker A** (the speaker with the Mode LED Status Indicator shining solid Red), **press and hold** the EcoCast Button  for 3 seconds. The Mode LED Status Indicator will flash Red / White.

- Once the connection between the speakers is successful, **Speaker C** (and **Speaker D**) will announce, "Connection successful," and start playing audio.

Notes:



- If all the speakers are turned off, then turned on, the speakers in EcoCast Receiving Mode (**Speakers B, C, and D**) will automatically re-connect to the speaker in EcoCast Transmitting Mode (**Speaker A**). If they do not automatically re-connected, please follow the above steps to reconnect.
- The EcoCast functionality has a maximum range of 30 feet between speakers.
- While connecting the speakers, make sure that they are within a few feet of each other.

EcoCast: Streaming Your FM Radio Station or Aux-In Audio to Multiple Speakers





The SE18E soundbar (**Speaker FM**) also has the capability to stream FM radio stations or Aux-In Audio to other EcoCast-enabled speakers in Receiving Mode.



When playing an FM radio station, the SE18E automatically enables EcoCast Transmitting; however, each time the Audio Mode is switched to Aux-In Audio, EcoCast Transmitting is disabled.

- To enable EcoCast Transmitting, press the  and  Buttons on the Control Panel at the same time. The SE18E will announce, "EcoCast enabled."

Audio Functions

- To disable EcoCast Transmitting again, press the  and  Buttons on the Control Panel at the same time. The SE18E will announce, "EcoCast disabled."

To transmit FM or Aux-In Audio streaming via EcoCast, follow the steps below:

1. Turn on another EcoCast-enabled speaker (**Speaker E**), press the Audio Mode Button  to cycle through to EcoCast Receiving Mode. The Mode LED Status Indicator will flash Green, and **Speaker E** will announce, "EcoCast receiving."
2. On **Speaker FM**, **press and hold** the EcoCast Button  for 3 seconds. The Mode LED Status Indicator will flash Red and White.
3. Once the connection between the speakers is successful, **Speaker E** will announce, "Connection successful," and start playing audio.

Play Audio Streams From Another EcoCast-Enabled Speaker

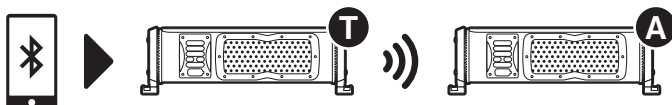



If there is an EcoCast-enabled speaker in EcoCast Transmitting Mode nearby, you can set your SE18E soundbar (**Speaker A**) to EcoCast Receiving Mode and play audio streams from the EcoCast Transmitting speaker (**Speaker T**):

1. Turn on **Speaker A**, press the Audio Mode Button  to cycle through to EcoCast Receiving Mode. The Mode LED Status Indicator will flash Green, and the speaker will announce, "EcoCast receiving."
2. On **Speaker T**, **press and hold** the EcoCast Button for 3 seconds. The LED Status Indicator will flash Red.

Note: If **Speaker T** is not an SE18E soundbar, it may require a different button operation to enter EcoCast Transmitting (Pairing Ready) Mode. Please refer to **Speaker T's** User Guide.

3. Once the connection between the speakers is successful, **Speaker A** will announce, "Connection successful," and start playing audio.

Note: A speaker in EcoCast Receiving Mode will play at the same volume level (Volume Sync) as received in the audio streams from the EcoCast Transmitting speaker. You can press  or  on the EcoCast Receiving speaker to adjust the volume for the EcoCast Receiving speaker only. However, as soon as the EcoCast Transmitting speaker has a playback change (e.g., track change or a volume change), the EcoCast Receiving speaker will once again Volume Sync with the Transmitting speaker.

Lighting Control Concepts

LED Lighting Zones, Modes, and Scenes

In addition to the buttons on its Control Panel, the SE18E soundbar can also be controlled by the included SoundExtreme Universal Remote Control and the SoundExtreme Smartphone App. Below are some terms and definitions to help you better understand the Remote Control and the SoundExtreme App.

Zone

A Zone corresponds to all the LED lights that are connected directly to one physical connection on an LED Lighting Controller output, either integrated in the SE18E or in an ExtremeController (sold separately). When you change a Zone status (on / off, Mode, etc.), the LEDs connected to that Zone will change accordingly. You can control one Zone or multiple Zones at a time.

The integrated LED Lighting Controller on the SE18E soundbar supports 2 Zones:

- Zone 1 – The RGB LED Party Lights behind the speakers on the front and sides of the soundbar.
- Zone 2 – The LED Light Bar on the back of the soundbar.

Mode

There are 3 LED Mode categories, totaling in 44 Modes supported by the RF Remote. The SoundExtreme app can support many more Color Modes.

1. Color Mode: Each Color Mode lights up the LEDs in a solid color. There are 8 Color Buttons on the Remote Control: Red, Green, Blue, White, Orange, Yellow, Cyan, and Purple. You can create a custom color by utilizing the SoundExtreme Smartphone App.
2. Party Mode: There are 20 preset Party Modes accessible via the Remote Control and SoundExtreme Smartphone App. The app allows you to customize each of the 20 Party Modes, allowing for nearly unlimited color, cascading, and LED chasing options.

3. Music Mode: There are 16 Music Modes accessible via the Remote Control and SoundExtreme Smartphone App.

Scene

A Scene is programmed via the SoundExtreme Smartphone App. You can customize each Zone into a Scene (a preset). Setting the Scenes on the app allows a 1-button press to bring up your desired custom settings for all of the LED products connected to the LED Lighting Controller.



The SE18E soundbar has 5 Scene settings. They are user customizable and programmable. The default Scene settings are:

- Scene 1: Patriot 1 (Red, White, and Blue)
- Scene 2: Flowing colors
- Scene 3: Zoom
- Scene 4: Fading colors
- Scene 5: Christmas (Red, Green, and White)

Control Panel: Lighting Control Buttons

There are 5 buttons on the SE18E Control Panel that are used to operate the LED Party Lights in the 2 Zones and the Utility Light on the back of the soundbar. Refer to the following table for an overview of the Lighting Control Buttons functionality.

Lighting Control Concepts

BUTTON	ACTION	FUNCTION
	Short-Press	<ul style="list-style-type: none">· To cycle through the 44 LED Modes in Zone 1.· If off, to turn on Zone 1.
	Press and Hold (for 3 seconds)	When on, to turn the Zone 1 off.
	Short-Press	<ul style="list-style-type: none">· If Party Lights are on, to cycle through the 44 LED Modes in Zone 2.· If off, to turn on Zone 2.· If Utility Light is on, to cycle through the 3 Brightness Levels.
	Press and Hold (for 3 seconds)	When Zone 2 (Light Bar Party Lights) is on, to turn Zone 2 off.
SCENES	Short-Press	To cycle through the 5 defined Scenes for both Zones.
	Press and Hold (for 3 seconds)	To turn on / off the rear-facing Utility Light.

NOTES

- There are 44 distinct LED Modes: 8 Color Modes, 20 Party Modes, and 16 Music Modes. You can also use the SoundExtreme Smartphone App to find a specific LED Mode.
- When turned on, Zone 1 will enter the last LED status it was in before powering off.
- Once a 44-Mode cycle is completed, the next short-press will turn the lights off. Turning lights back on will restart the cycle.

- There are 44 distinct LED Modes: 8 Color Modes, 20 Party Modes, and 16 Music Modes. You can also use the SoundExtreme Smartphone App to find a specific LED Mode.
- When turned on, Zone 2 will enter the last LED status it was in before powering off.
- Once a 44-Mode cycle is completed, the next short-press will turn the lights off. Turning lights back on will restart the cycle.
- When the Utility Light is on, each short-press will cycle through 3 Brightness Levels: high, mid, and low.

- The Party Lights in both Zones will light up as defined by Scene 1. Each following short-press will cycle through the next 4 Scenes.
- If the Party Lights in Zone 2 are on, turning on the Utility Light will automatically turn the Party Lights in Zone 2 off.

Lighting Control Concepts

Light Bar: Utility Light and Zone 2 RGB LED Party Lights

The Utility Light (White) and the Zone 2 Party Lights are co-located on the same Light Bar on the back of the SE18E soundbar. To avoid the lighting interferences between the Utility Light and Party Lights, the button functions are designed to prevent the Utility Light and Party Lights from being turned on at the same time.

- Short-press the Zone 2 Button  to turn the Party Lights on.
 - If the Party Lights in Zone 2 are on, turning on the Utility Light will automatically turn the Party Lights in Zone 2 off.
- **Press and hold** the Scenes Button to turn the Utility Light on / off.
 - When the Utility Light is on, the SE18E will **NOT** allow the Zone 2 Party Lights to turn on. You **MUST** turn the Utility Light off before you turn the Zone 2 Party Lights on.
 - When the Utility Light is on, you can short-press the Z2 Button to change the Brightness Level: high, mid, low.

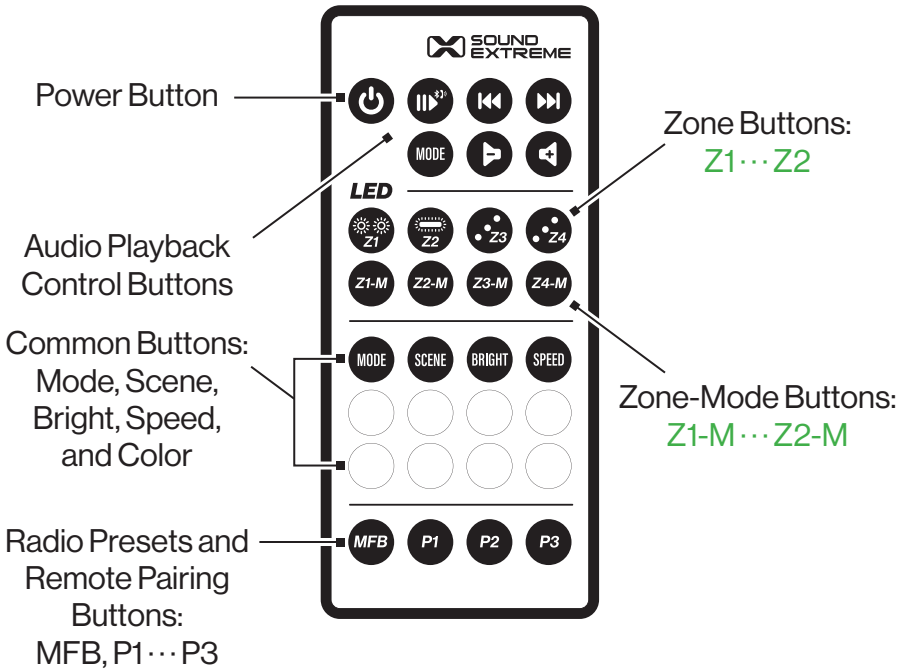

The SE18E soundbar comes with a SoundExtreme Universal Remote Control.

Basic Functions

1. Power, Mode, and all the Audio Playback Control Buttons on the Remote Control have the same functions as their corresponding buttons on the Control Panel.

Note: There are two Mode Buttons on the Remote Control. The Mode Button at the top is for Audio Mode. The Mode Button in the middle is for LED Party Light Mode.

2. LED Lighting Control Buttons: There are 20 buttons on the RF Remote Control that are used to operate the LED Party Lights in the 2 Zones and the Utility Light on the back of the soundbar. The Zone Buttons (Z1, Z2) and Zone-Mode Buttons (Z1-M, Z2-M) affect individual Zones. (Z3, Z4, Z3-M, and Z4-M have

RF Remote Control

no function). The Common Buttons (LED Mode, Scene, Bright, Speed, and 8 Color Buttons) affect both Zones at once.

3. MFB, P1, P2, and P3 Buttons:

- When the soundbar is in FM mode, P1, P2, and P3 Buttons serve as 3 Preset Buttons:
 - i. **Press and hold** a Preset Button for 2 seconds to save the current station to the corresponding Preset.
 - ii. Short-press a Preset Button to tune to the saved station corresponding to that Preset Button.
- In combination with the MFB Button, use the P1, P2, or P3 Buttons to pair one Remote Control with up to 3 speakers / soundbars or to select an individual product to control.

Remote Control Pairing and Speaker Selection

The SoundExtreme Universal Remote Control can pair with and save up to 3 soundbars in its memory as P1, P2, and P3 speakers. The included Remote Control comes paired with the SE18E soundbar as the P1 speaker. You can use it out-of-the-box to control the speaker after it is powered on.

If the speaker does not react when you press a button on the Remote Control, check if the battery isolator (clear plastic strip) on the Remote battery compartment is removed (pulled out) completely. Then, follow the steps below.

Remote Control Pairing

1. When the soundbar is on, **press and hold** both the  and  Buttons on the speaker at the same time for 3 seconds. The soundbar's LED Party Lights will flash Green, indicating the speaker is ready to pair with a remote.
2. **Press and hold** the MFB Button for 3 seconds, then press P1 (P2, or P3) to save the pairing soundbar as the P1 (P2, or P3)

speaker. Once paired, the soundbar's LED Party Lights will rapidly flash Green 3 times.

Select a Soundbar to Control

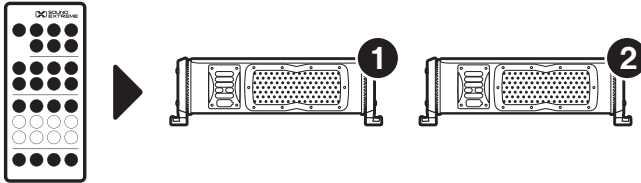

Assuming your Remote Control has paired with **Soundbar 1** and **2** as P1 and P2 soundbars, **Soundbar 1** is currently controlled by the Remote Control. If you want to use the Remote Control to control **Soundbar 2**, follow the steps below.

1. **Press and hold** the MFB Button for 3 seconds, **Soundbar 1**'s Party Lights will flash Blue, indicating your remote is in the process of speaker selection.
2. While **Soundbar 1** is flashing Blue, press P2. The Party Lights on **Soundbar 2** will flash Blue 3 times and produce a prompt double-beep tone, indicating **Soundbar 2** is selected.
3. Press a button on the Remote Control. **Soundbar 2** will produce the corresponding action, while **Soundbar 1** will have no response.

Soundbar Party Lights and Utility Light Control

When the SE18E soundbar is on, you can use the Remote Control to change the Party Lights and Utility Light.

Zone 1 to Zone 2: Party Lights – Lighting Mode Control

1. **Press and hold** the Power Button to turn on / off all the Party Lights.
2. Press the Z1 or Z2 Button. The Party Lights will briefly light up Green in ascending order and then shine solid Orange or a random color pattern.

RF Remote Control

3. Now you can change the LED Lighting Mode by short-pressing one of the Zone-Mode Buttons (Z1-M or Z2-M) to cycle through the three LED Mode categories for only the corresponding Zone.

Note: There are 44 distinct LED Modes. Instead of using a Zone-Mode Button to cycle through to a desired LED Mode, you can also use the SoundExtreme Smartphone App to find a specific LED Mode.

Common Buttons: Modifying Both Zones

You can change the LED Lighting Mode in both Zones with one of the following button presses:

- Short-press the LED Mode Button. Each short-press will cycle through all 44 LED Modes.
- Short-press the Scene Button to cycle through the 5 Scenes.
- Short-press the Bright Button to cycle through 5 levels of brightness.
- Short-press the Speed Button to cycle through 5 levels of speed. The lighting patterns, as defined by the selected LED Lighting Mode, will progress more quickly with each short-press.
- Short-press one of the 8 Color Buttons to light the LEDs in the corresponding color

Refer to the **Remote Functions Overview** chart for more details.

Utility Light Control

The Utility Light can be controlled by the Scene Button and the Z2-M Button.

1. **Press and hold** the Scene Button to turn on the Utility Light.
2. When the Utility Light is on, short-press the Z2-M Button to cycle through 3 Brightness Levels: high, mid, and low.
3. **Press and hold** the Scene Button to turn off the Utility Light.

Advanced Functions

Cycle to Previous Mode

As previously indicated, you can cycle through the 44 distinct LED Modes in both Zones or in individual Zones. You can also cycle back to the previous LED Mode:

- To cycle back to the previous LED Mode for **BOTH** Zones, double-click the LED Mode Button.
- To cycle back to the previous LED Mode in a single Zone, double-click one of the Zone-Mode Buttons (Z1-M or Z2-M).





Common Buttons: Modifying a Single Zone

As previously indicated, a short-press of any of the Common Buttons will change the LED lighting effect in both Zones. You can also change the LED lighting effect in only 1 Zone at a time:

1. To activate the Zone you want to change, **press and hold** the Zone Button. For example, **press and hold** the Z1 Button for 3 seconds. The LEDs in Zone 1 will flash Green twice, indicating that Zone 1 is selected.
2. You can now **press and hold** any of the 8 Color Buttons, the Bright Button, or the Speed Button for 2 seconds (instead of a short-press) to modify the LEDs in the selected Zone.
3. To change another Zone, e.g. Zone 2, **press and hold** the Z2 Button. The LEDs in Zone 2 will flash Green twice, indicating that Zone 2 is selected. Follow step 2 to modify the LEDs in Zone 2.

Note: Any time you short-press a Common Button on the Remote, it will change the LEDs in both Zones.





Remote Functions Overview

BUTTON	ACTION	FUNCTION
	Press and Hold (for 3 seconds)	Turn on / off the LEDs in all Zones.
	Short-Press	Turn on / put the soundbar into Standby Mode.
	Short-Press	To play / pause audio.
	Short-Press	<ul style="list-style-type: none"> · In Bluetooth Mode: To skip to the previous or the next track. · In FM Mode: To tune in a station.
	Press and Hold (for 3 seconds)	In FM Mode: To seek a strong station.
	Short-Press	To Change Audio Modes.
	Press and Hold (for 3 seconds)	To enable EcoCast pairing.
	Short-Press	To increase or decrease the speaker's volume.
	Press and Hold Both (for 3 seconds)	To adjust the volume continually.

NOTES

- When turned on, each of the LEDs will light up Green in ascending order. When turned off, the LEDs light up Red in descending order.
- When in Standby Mode, the speaker consumes minimal power.
- There are 5 Audio Modes – Bluetooth, EcoCast Transmitting, EcoCast Receiving, FM, and Aux-In.
- The speakers will emit a tone to indicate when maximum or minimum volume setting is reached.

Remote Functions Overview







BUTTON	ACTION	FUNCTION
	Short-Press	To turn on / off each Zone.
	Press and Hold (for 3 seconds)	To select a single Zone.
	Short-Press	<ul style="list-style-type: none">· To cycle through the three LED Mode categories for the selected Zone.· Z2-M Only: If Utility Light is on, to cycle through the 3 Brightness Levels (high, mid, low).
	Double-Click	To cycle back to the previous LED Mode for the selected Zone.
	Short-Press	To cycle through the three LED Mode categories for all Zones.
	Double-Click	To cycle back to the previous LED Mode for all Zones.
	Short-Press	To cycle through the 5 defined Scenes for all Zones.
	Press and Hold (for 3 seconds)	To Turn on / off the rear-facing Utility Light.

Remote Functions Overview

NOTES

- When turned on, LEDs in the selected Zone will light up Green in ascending order. When turned off, the LEDs light up Red in descending order.
- The LEDs in the selected Zone will rapidly flash Green twice. You can now **press and hold** one of the Common Buttons to change the Brightness, Speed, or Color for the selected Zone.
- There are 44 distinct LED Modes: 8 Color Modes, 20 Party Modes, and 16 Music Modes. You can also use the SoundExtreme Smartphone App to find a specific LED Mode.
- There are 44 distinct LED Modes: 8 Color Modes, 20 Party Modes, and 16 Music Modes. You can also use the SoundExtreme Smartphone App to find a specific LED Mode.
- If the Party Lights in Zone 2 are on, turning on the Utility Light will automatically turn the Party Lights in Zone 2 off.

Remote Functions Overview

BUTTON	ACTION	FUNCTION
	Short-Press	To cycle through 5 levels of Brightness / Speed for all Zones.
	Press and Hold (for 2 seconds)	To cycle through 5 levels of Brightness / Speed for the selected Zone.
	Short-Press	To select the corresponding Color for all Zones.
	Press and Hold (for 2 seconds)	To select the corresponding Color for the selected Zone.
	Press and Hold (for 3 seconds)	To select a speaker to control.
	Press and Hold (for 2 seconds)	When in FM Mode: To save the current station to the P1 Button.
	Short-Press	When in FM Mode: To tune to the station saved to the P1 Button
	Press and Hold (for 2 seconds)	When in FM Mode: To save the current station to the P2 Button.
	Short-Press	When in FM Mode: To tune to the station saved to the P2 Button
	Press and Hold (for 2 seconds)	When in FM Mode: To save the current station to the P3 Button.
	Short-Press	When in FM Mode: To tune to the station saved to the P3 Button

NOTES

- You must first **press and hold** the corresponding Zone Button to select a Zone before using this feature.

- There are 8 Color Buttons on the Remote Control: Red, Green, Blue, White, Orange, Yellow, Cyan, and Purple. You can also use the SoundExtreme Smartphone App to create a custom color.

- You must first **press and hold** the corresponding Zone Button to select a Zone before using this feature.

- Refer to **Remote Control Pairing and Speaker Selection** for more details.

- Refer to **Remote Control Pairing and Speaker Selection** for more details.

- Refer to **Remote Control Pairing and Speaker Selection** for more details.

- Refer to **Remote Control Pairing and Speaker Selection** for more details.

SoundExtreme App

The SE18E soundbar can be operated via the SoundExtreme Smartphone App.

Download and Install

For iPhones, download the app from the following URL:

<https://apps.apple.com/us/app/soundextreme/id1670708941>

For Android phones, download the app from the following URL:

<https://play.google.com/store/apps/details?id=com.cchip.ecoxgear>

Alternatively, use the following QR Codes to download the SoundExtreme Smartphone App.



iOS



Android

App Overview

Password Secured: The app is password protected so others cannot gain access and control your SE18E. The default password is 0000.

Name Your Devices: You can change and customize the name of your devices and Zones, such as Rear speakers, Soundbar, etc.

Set Up Modes: Use the app to set up the LED Mode for each of the Zones on your soundbar. You can also change the Brightness and Speed.

Create and save Scenes: A Scene is a preprogrammed light show that you can save for later quick-access. We have created 5 default Scenes that are fully customizable and programmable.

Set Up a Group: Create and set up a group of devices (multiple soundbars, or other SoundExtreme products with LEDCast built-in). This will allow all the LED lights connected to different devices to be controlled by the SoundExtreme Smartphone App at the same time.

Bluetooth Low Energy: The SoundExtreme Smartphone App relies on a BLE (Bluetooth Low Energy) connection between your phone and the SE18E. Make Sure you turn on Bluetooth on your smartphone.

Initial App Connection

1. Launch the SoundExtreme App on your smartphone or other BLE-enabled device.
2. On the SoundExtreme App homepage, tap **Device Connection List**.



SoundExtreme App

3. If your SE18E is powered on, it will show up as **LEDs-SE18** on the app's **Connect Device** screen. Tap the device name on the screen. A check mark will appear on the right. Tap the **Connect** button.

4. A dialog window will popup asking you to enter a password. The SE18E default password is 0000.

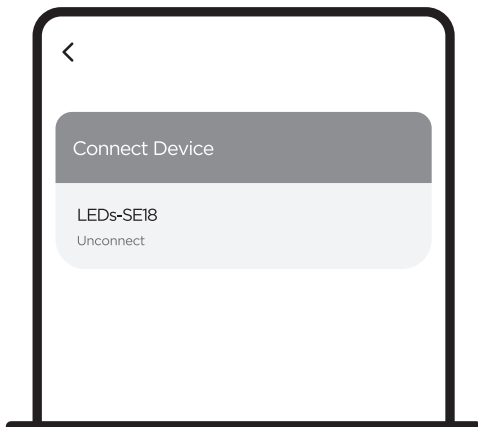

5. Select your SE18E. It will take you to the **Scene** screen. There are 5 predefined Scenes on the SE18E. You can turn on one of the 5 Scenes to light up the LEDs. For example, tap the On / Off button  at the right for Scene 1. The Party Lights will light up Red, White, and Blue, which is the LED Lighting Mode defined for Scene 1 – Patriot 1.

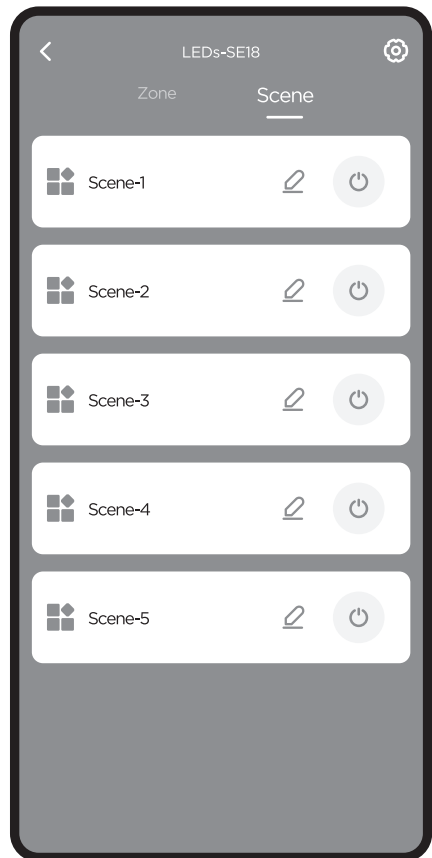
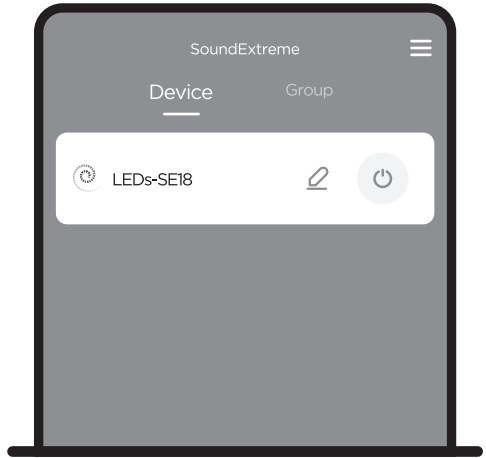

SoundExtreme App

Set Up Zones

1. Select your SE18E on the Device list, and the app will bring you to the **Zone** screen.
2. Tap one of the 2 Zones, and you will go to the Zone LED Mode Settings screen. There are 3 tabs: Color, Party, and Music, which allow you to select a solid Color, a Party Mode, or a Music Mode.

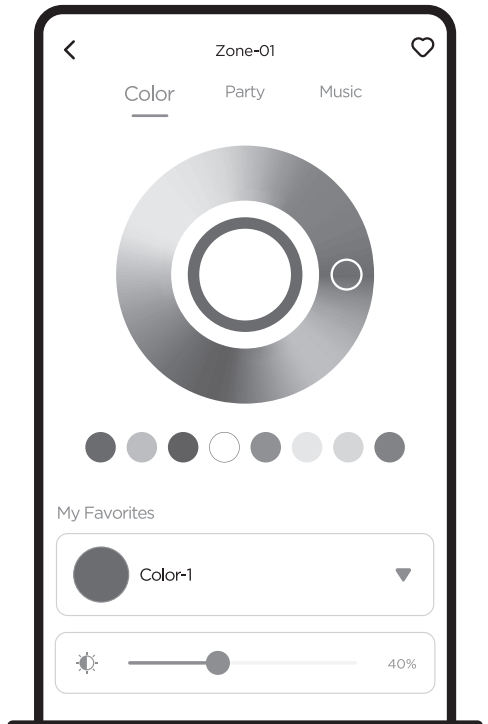
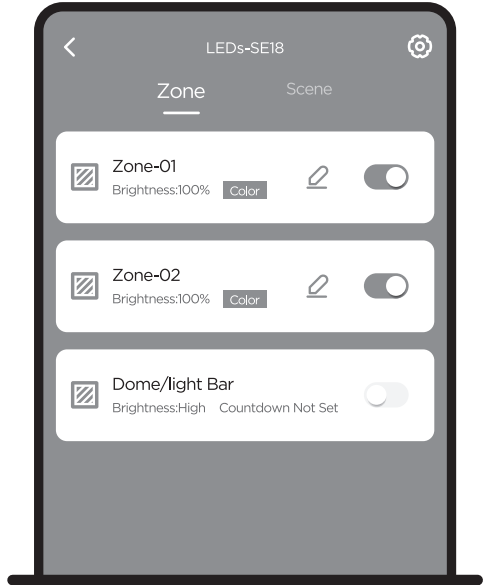

- When you choose a Mode, the LEDs connected to the Zone you selected will light up accordingly, giving you a preview.
- If you tap the **Save** button on the screen, the app will save your setting for the selected Zone.
- If you tap the **Cancel** button or exit the LED Mode Settings screen, your Mode selection will not be saved and LEDs connected to that Zone will display the previously selected LED Mode.

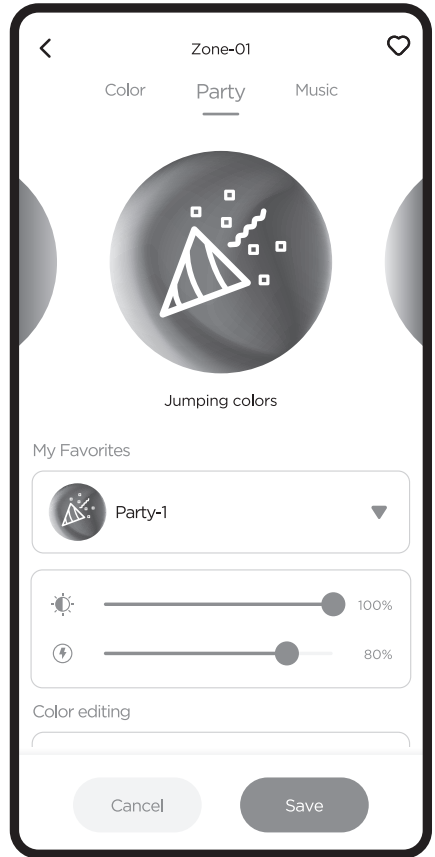

SoundExtreme App

3. After you set up the Modes for each of the Zones, the SE18E setup is complete.

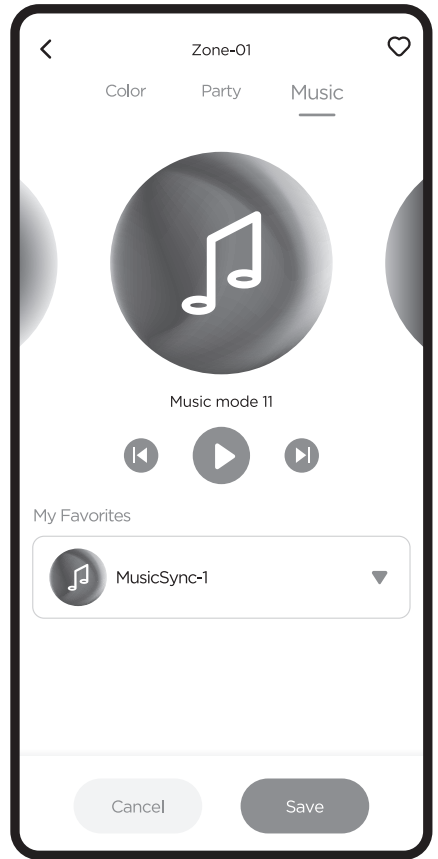

Set Up Scenes

1. On the **Device** List screen, select your SE18E (**LEDs-SE18**) and the app will bring you to the **Zone** screen. Tap the **Scene** tab. The app will show 5 predefined scenes on your SE18E.
2. You can change a Scene's LED settings by selecting any of the 5 Scenes. When you select the Scene, you will go to the LED Mode Setting screen. You can use the same procedure as in the **Set Up Zones** section to set up each Zone and save the Scene's new LED settings.
3. After you set up LED Modes for all the Zones, the setup is complete for the selected Scene.



SoundExtreme App

Utility Light Control

You can control the SE18E's rear-facing Utility Light with the following steps:

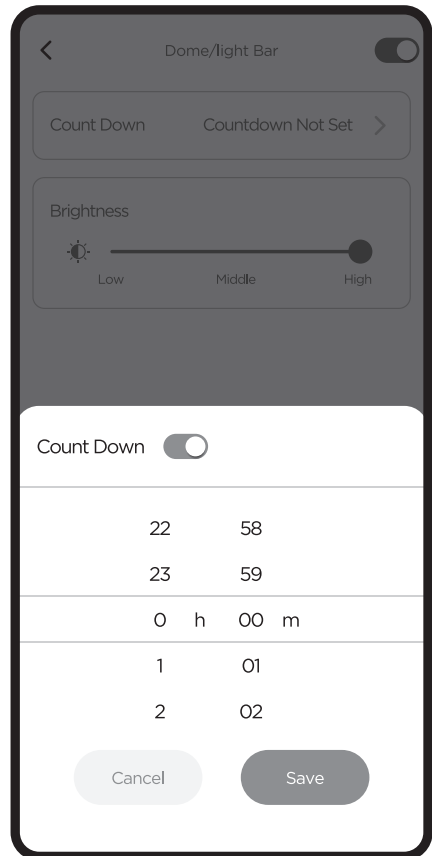
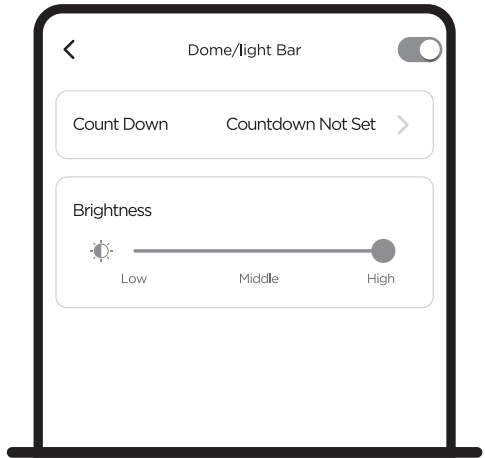

1. On the **Device** List screen, select your SE18E (**LEDs-SE18**), and the app will bring you to the **Zone** screen.
2. On the **Zone** screen, tap **Dome/Light Bar** (Zone 2) and you will go to the **Dome/Light Bar** Settings screen. As previously indicated, once the Utility Light is turned on, the Zone 2 RGB LED Party Lights will turn off automatically.
3. There are 3 Brightness Levels (High, Mid, and Low) on the slide bar for you to choose from.
4. You can also set a countdown timer for the Utility Light by tapping **Count Down**. Set up a time on the countdown timer from the popup window. Once the countdown is over, the app will turn off the Utility Light.



Change Password

To add extra security, you can change the default password of 0000 to your desired 4-digit numeric password. Please note that the password is stored in your SE18E, not the SoundExtreme App. So, after you change the password, please make a note in case you forget your password. The password won't be reset by reinstalling the app or changing to another smartphone. The only way to reset your password is to conduct a factory reset on your SE18E soundbar.

Follow the steps below to change your password:

1. Select the Menu Icon  at the top-right corner of the screen.
2. Select  **Device Password** from the menu.

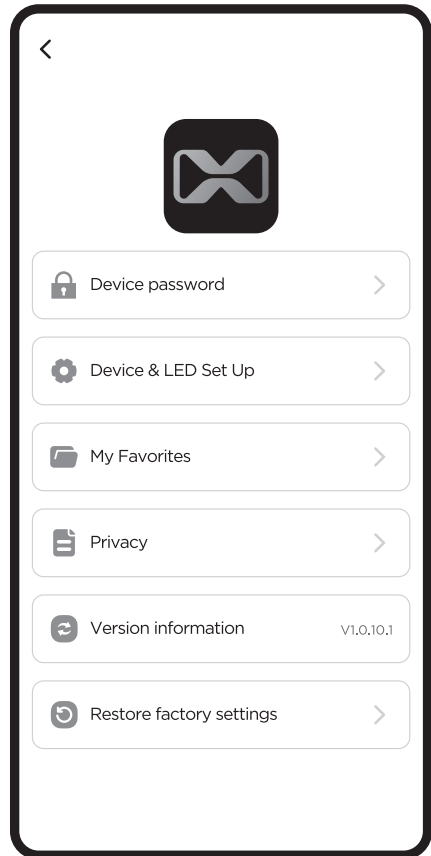

SoundExtreme App

3. Once at the Device Password screen, select the device that you want to change the password to.
4. Enter the current password, the new password, and re-enter the new password. Then tap the **Confirm** button.
5. If the change is successfully saved, the app will display a confirmation message.

This is a one-time event. You do not have to enter in your password every time you launch the app, as your app will remember your password.

The screenshot shows the 'Device password' screen in the SoundExtreme app. At the top left is a back arrow, and at the top right is the title 'Device password'. Below the title is a list of devices, with 'LEDs-SE18' selected and a chevron icon to its right. Underneath are three password input fields: 'Current password' (with 'password' entered), 'New password' (with 'password' entered), and 'Reenter new password' (with 'password' entered). Below these fields is a note: '* The password is 4 characters'. At the bottom of the screen is a large, rounded 'Save' button.

Factory Reset

If you forget the password, you will need to do a Factory Reset on the SE18E so that the password is reset to its default value: 0000.

- While the SE18E is turned on, **press and hold** the , , and  Buttons on the Control Panel at the same time for 3 seconds. The SE18E will produce a prompt triple-beep tone, to show that the reset is successful.

Note: Besides the password reset, a Factory Reset will also configure the SE18E to the following factory settings:

- All Zones are set to Scene 1 – Patriot 1 with 100% Brightness and the Speed is set to 80%.
- All 5 customer configurable Scenes are set to the Factory Default Scenes.
- All 3 FM station Presets are cleared.
- All the EcoCast and Bluetooth pairing records are erased.

Specifications

Unit Dimensions

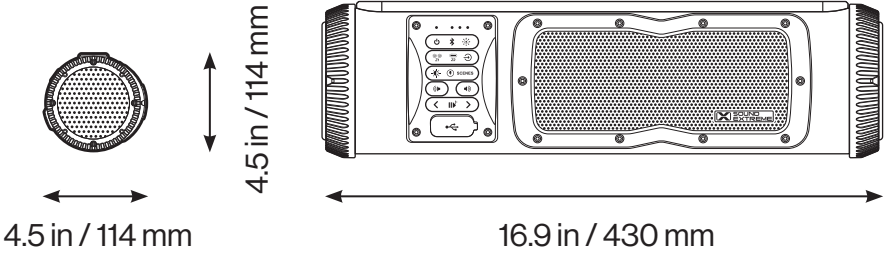

Unit + Mount Dimensions

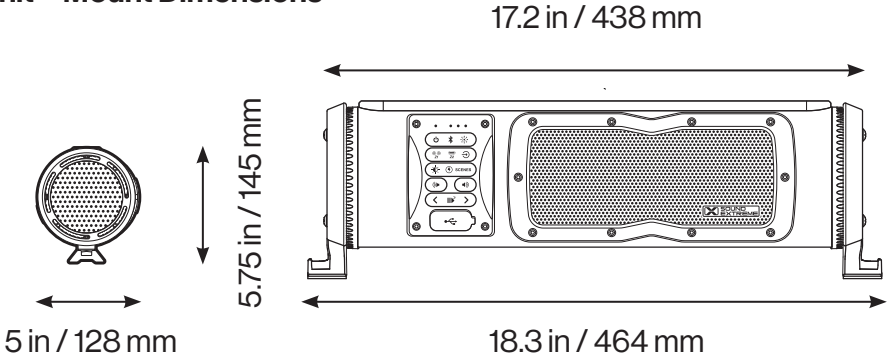

Unit Weight

8 lbs

Unit + Mounts Weight

8.5 lbs

Bluetooth Compliance

Bluetooth V 5.1

Bluetooth Frequency Band

2.402~2.480GHz ISM Spectrum

Modulation

GFSK, $\pi/4$ -DQPSK, 8DPSK

Bluetooth Range

Up to 100 ft / 30m

Tweeter (1x)

1.5" (38 mm) tweeter

Woofers (2x)

4" (102 mm) woofer

Mid-Range Speaker (2x)

2.25" (57 mm) speaker

Audio Output Power

300W (peak)

Power Supply

Input Voltage: 12VDC, 10A
(requires connection to external DC battery for power)

USB Output

5V, 2.1A

EcoCast Range

30 ft / 9.1 m between Casting speaker and Receiving speakers

Radio Frequency Range

US: FM 87.5 - 107.9 MHz

RF Remote Operating Frequency

433 MHz

Power Cable In-Line Blade Fuse

15A, 32V

Storage Temperature

-40°F to 122°F / -40°C to 50°C

Operating Temperature

23°F to 95°F / -5°C to 35°C

Waterproof / Dustproof Rating

IP66

Important Legal Information

FCC STATEMENT:

This device complies with Part 15 of the FCC Rules. Operation is subject to the following two conditions:

- 1.) This device may not cause harmful interference, and
- 2.) This device must accept any interference received, including interference that may cause undesired operation.

WARNING: Changes or modifications not expressly approved by the party responsible for compliance could void the user's authority to operate the equipment.

NOTE: FCC's RF Exposure guidelines, this equipment should be installed and operated with minimum distance between 20cm the radiator to your body.

This equipment has been tested and found to comply with the limits for a Class B digital device, pursuant to Part 15 of the FCC Rules. These limits are designed to provide reasonable protection against harmful interference in a residential installation. This equipment generates, uses, and can radiate radio frequency energy and, if not installed and used in accordance with the instructions, may cause harmful interference to radio communications. However, there is no guarantee that interference will not occur in a particular installation. If this equipment does cause harmful interference to radio or television reception, which can be determined by turning the equipment off and on, the user is encouraged to try to correct the interference by one or more of the following measures: reorient or relocate the receiving antenna, increase the separation between the equipment and receiver, connect the equipment into an outlet on a circuit different from that to which the receiver is connected, consult the dealer or an experienced radio/TV technician for help.

RF WARNING STATEMENT:

The device has been evaluated to meet general RF exposure requirement. The device can be used in portable exposure condition without restriction.

IC STATEMENT:

This device complies with Industry Canada licence-exempt RSS standard(s). Operation is subject to the following two conditions:

- 1.) This device may not cause interference, and
- 2.) This device must accept any interference, including interference that may cause undesired operation of the device.

PRODUCT USE AND PROTECTION:

Read and follow all instructions. Use only as intended.

The SoundExtreme unit is intended to be used indoors or outdoors and in land or water environments. The unit has been tested to IP66 waterproofing standards, which means the unit can be exposed to dust and water, but should **NOT** be submerged underwater.

To prevent fire or shock, do **NOT** attempt to power this unit if it is wet or you suspect water has entered the unit. In this situation, please return the unit to SoundExtreme for a free assessment. If we have found that the unit has carried water, we will repair or replace the unit free of charge.

SAFETY ADVISORY & WARNING:

Read and follow all instructions. Use only as intended.

CAUTION: Do **NOT** open to repair. A qualified technician must carry out repair work.

ATTENTION: Do **NOT** connect to a SoundExtreme product with LEDCast technology while the unit is wet. Make sure all connections are dry **BEFORE** connecting to a power source. Failure to do so may result in electrical damage to the unit and may void the warranty.

⚠ WARNING: Cancer and Reproductive Harm - www.P65Warnings.ca.gov

ATTENTION: Do **NOT** dispose of in a landfill. Contact a certified recycling agent to dispose of the unit.

SAFETY:

This product has a limited life span of use and should be replaced when it shows obvious signs of wear.

Do not modify or remove any original component parts of the speaker. Doing so could cause damage to the unit, allowing water to ingress. A unit with water ingress should not be charged due to potential risk of fire or shock.

Please exercise care and good judgment when using your SoundExtreme unit.

You should always

- 1.) Return the unit to Infinity if you suspect water ingress into the unit or if the unit has experienced a severe impact that may have affected the integrity of the unit to take on water.

Important Legal Information

You should never

- 1.) Never power your SoundExtreme unit if you suspect water has entered the device. Powering a device with water inside could be potentially hazardous and cause fire or a spark.
- 2.) Never use your SoundExtreme unit if you have dropped it or thrown it against a hard surface which may have destroyed the integrity of the housing. In the event of a severe impact to your unit, please return the unit to SoundExtreme to review for potential damage.
- 3.) Never attempt to fix, repair your SoundExtreme unit. Please send it back to Enfinity for any assessments and repairs.

CARE, MAINTENANCE & PRECAUTIONS:

- 1.) Do **NOT** apply excessive force to any surfaces of the unit.
- 2.) Do **NOT** use or store the unit in places with high temperature.
- 3.) **AVOID** prolonged exposure to ultraviolet radiation (UV sunlight) and strong magnetic fields.

LIMITED MANUFACTURER'S WARRANTY:

The SE18E is covered by a 1-year limited warranty that covers defects in workmanship and/or materials for a period of 1 year from original purchase date. This warranty does not apply to any products which have been abused, neglected, modified or used for a purpose other than the one for which they were manufactured. Please refer to the above care and maintenance instructions for suggested care details. The warranty is valid only for the original owner who purchases the unit from an authorized dealer. Transfers do not qualify for warranty protection. SoundExtreme reserves the right to replace any out-of-stock or discontinued product with a comparable product. Discontinued products may not be available for warranty replacement. Any contents are **NOT** covered by the limited manufacturer's warranty. Warranty terms may be revised without notification at the discretion of the manufacturer. Please visit www.soundextreme.com.au for additional product & warranty information.



SOUNDEXTREME and ECOXGEAR are the registered trademark of Enfinity Pty Ltd
Designed in USA. Made in China.

This product is protected under patent US 9,307,307 B2 and several patents pending.

What's in the Box

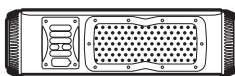

SoundExtreme Speaker



SoundExtreme
User Guide

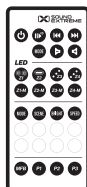

RF Remote
Control

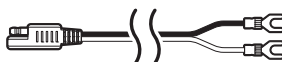

8ft Power Cable



(2x) 1/4-20 SHCS Bolt –
3.5" long

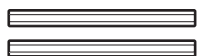

(2x) Rubber
Sleeves



Allen Wrench
for 1/4-20



(2x) 1/4-20 SHCS
Bolt – 2" long



(2x) 1/4-20 Stud –
1.5" long

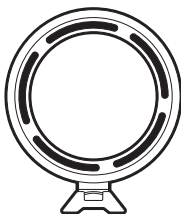
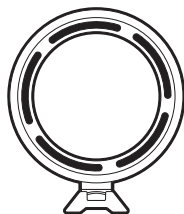

(2x) Mounts



(2x) 1/4-20 SHCS
Bolt – 1.25" long



(2x) 1/4-20 SHCS
Bolt – 0.5" long



(8x) #8-32 Button
Head Bolts



(2x) 1/4-20
Washer (S)



(2x) Rubber
Feet

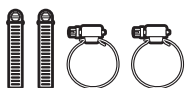

(4x) Worm Clamps
- 1/2" Width



(2x) 1/4-20
Washer (L)



(2x) 1/4-20
Nut