



# Operating Instructions

## UHF390P 80 Channel UHF Citizen Band Radio

Keep this user guide for future reference. Always retain your proof of purchase in case of warranty service.

[www.oricom.com.au](http://www.oricom.com.au)

When a narrowband radio receives a transmission from an older wideband radio the speech may sound loud and distorted – simply adjust your radio volume for the best listening performance. When an older wideband radio receives a signal from a new narrowband radio the speech may sound quieter - simply adjust your radio volume for best listening performance. When operating a narrowband radio on Channel 41 - 80 interference is possible from wideband radios transmitting on high power or on adjacent frequency.

The issues described above **are not a fault of the radio** but a consequence of mixed use of wideband and narrowband radios.



This unit complies with all relevant Australian and New Zealand approval requirements AS/NZS 4365:2011



Controls and Indicators.....	4
Important information.....	7
Installation of your Oricom Radio .....	8
Operations .....	12
UHF CB channels and frequencies .....	28
Express Warranty (Australia).....	32

## Need Help?

If you need assistance setting up or using your Oricom product now or in the future, call Oricom Support.

Australia (02) 4574 8888  
[www.oricom.com.au](http://www.oricom.com.au)  
Mon-Fri 8am – 6pm AEST

New Zealand 0800 67 42 66  
[www.oricom.co.nz](http://www.oricom.co.nz)  
Mon-Fri 10am – 8pm NZST

## Controls and Indicators

### Front View of Controller Speaker Microphone

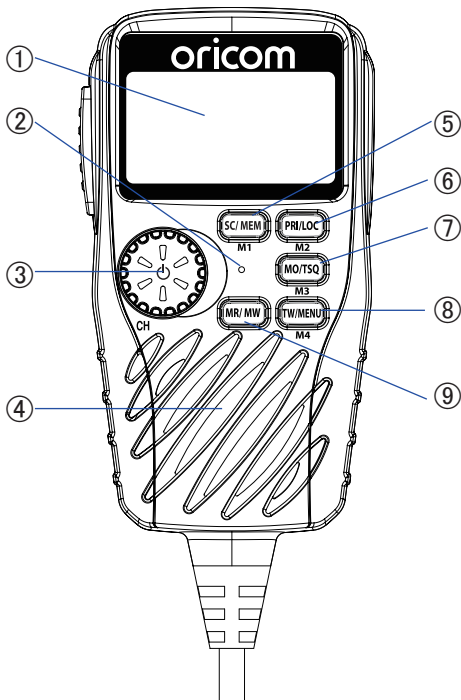

- |                                  |  |
|----------------------------------|--|
| 1. LCD display                   | 6. Priority channel recall/Key lock/Memory 2 |
| 2. Microphone                    | 7. Monitor/Tone Squelch/Memory 3             |
| 3. On/Off/Volume/Channel/Squelch | 8. Triple watch/Memo/Memory 4                |
| 4. Speaker                       | 9. Memory recall/Memory write                |
| 5. Scan/Memory skip/Memory 1     |  |

## Rear view of Radio

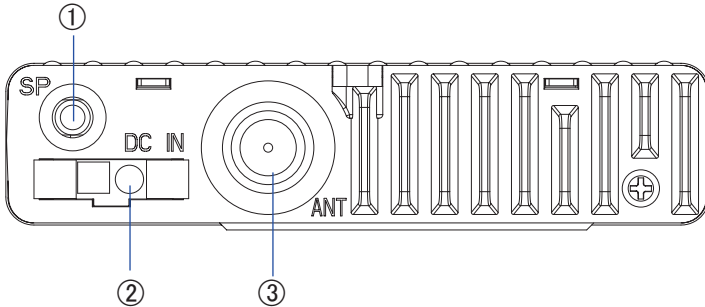

1. 3.5mm external jack for optional 8 ohm speaker
2. Power supply connection
3. Antenna Jack

## Pack Includes

- 1 x UHF CB radio transceiver
- 1 x Heavy duty controller speaker microphone
- 1 x Microphone mounting bracket
- 1 x Transceiver mounting bracket
- 1 x Microphone extension cable
- 1 x Pass-through extension cable
- 1 x Mounting hardware

## LCD Icons & Indicators

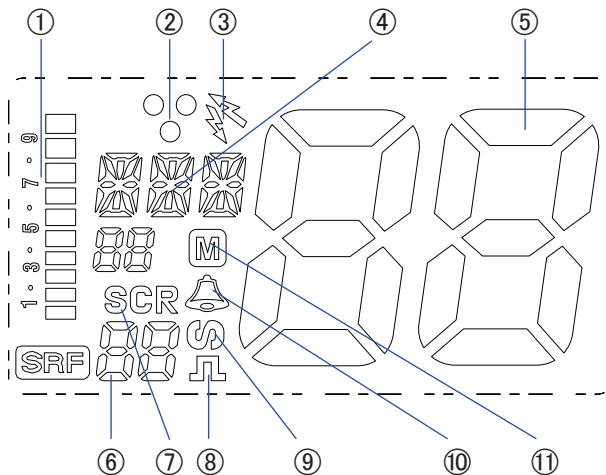

- |   |                                 |
|---|---------------------------------|
| 1. Signal strength RF output & TX meter (SRF) | 6. CTCSS or DCS channel display |
| 2. Triple watch on                            | 7. Scrambler on                 |
| 3. Duplex on                                  | 8. DCS on                       |
| 4. Status display                             | 9. CTCSS on                     |
| 5. Channel display                            | 10. Roger Beep on               |
|   | 11. Memory channel              |

## Please read before installing or operating your Oricom radio

The operation of your UHF radio in Australia and New Zealand is subject to conditions in the following licenses:

In Australia, the ACMA Radio communications (Citizen Band Radio Stations) and in New Zealand by MED the General User Radio License for Citizen Band Radio.

## Safety Information and Warnings



WARNING

### **Potentially Explosive Atmosphere**

Turn your radio OFF when in any area with a potentially explosive atmosphere. Sparks in such areas could cause an explosion or fire resulting in injury or even death.

**NOTE:** Areas with potentially explosive atmospheres are often, but not always clearly marked. They include fuelling areas such as below deck on boats; fuel or chemical transfer or storage facilities; areas where the air contains chemicals or particles, such as grain, dust, or metal powders; and any other area where you would normally be advised to turn off your vehicle engine.

### **Blasting Caps and Areas**

To avoid possible interference with blasting operations, turn your radio OFF near electrical blasting caps or in a “blasting area” or in areas posted: “Turn off two way radios.” Obey all signs and instructions.

### **Electromagnetic Interference/Compatibility**

Nearly every electronic device is susceptible to electromagnetic interference (EMI). To avoid the possibility of electromagnetic interference and/or compatibility conflicts, turn off your radio in any location where posted notices instruct you to do so such as health care facilities.

## Fitting the Controller Speaker Microphone

The controller speaker microphone uses a 6-pin telephone style plug and socket:

1. Position the microphone plug so the plastic flap faces downwards, and insert the plug into the socket until it 'clicks'.
2. Gently press the rubber boot into the hole surrounding the socket so that the slot around the boot fits neatly inside the rim of the entry hole.

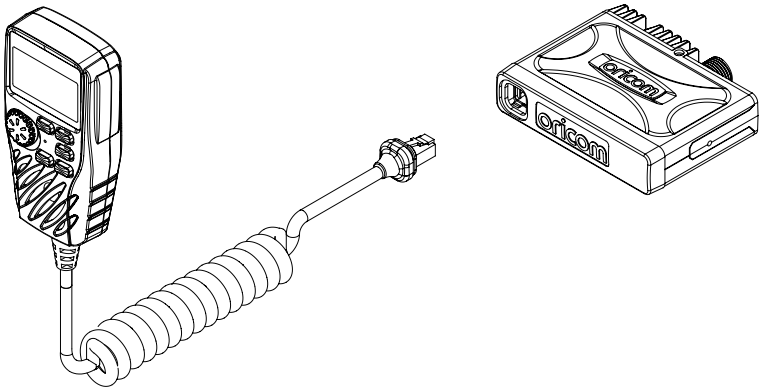

## Extension Cable Accessory

**A. Using microphone extension cable, microphone is installed to socket end, and plug end is installed into transceiver.**

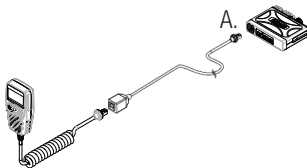

This microphone extension cable is typically used where the transceiver is mounted away from the driver. For example; Under the seat or behind the center console. This gives the user extra cable length to the microphone, allowing for more installation options.



- B. Using pass-through extension cable, plug one end into the rear of the pass-through and the other end into the transceiver. Plug the microphone into pass-through.**

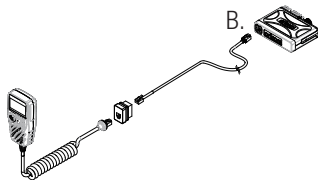

This pass-through extension cable is used when a UHF pass through connector (not supplied) is installed in the vehicle dash. Simply plug the extension cable from the transceiver to the back of the pass-through connector, then plug your microphone into the pass-through connector when using the radio. When the radio is not in use, user can unplug the microphone and store in a safe place.

### **Disconnecting the Controller Speaker Microphone**

It is recommended that the Controller Speaker Microphone be left permanently connected to the radio, but if it must be disconnected, proceed as follows:

1. Lift the rubber boot and the lip of the raised area on the front panel.
2. Ease the rubber boot out of the cable entry hole and slide it along the cable away from the front panel.
3. Identify the plug locking lever, and move the lever towards the plug body. At the same time gently pull the plug from the socket.



When installing your radio in your vehicle, check that during installation you do not damage any wiring or vehicle components that may be hidden around the mounting position.

Ensure the installation does not interfere with the operation of the vehicle and meets all regulatory and safety requirements for accessories fitted to your vehicle.

For optimum performance, your radio needs to be installed correctly. If you are unsure about how to install your radio, we suggest you have your radio professionally installed by a UHF specialist or Auto electrician. When installing the radio, avoid mounting it close to heaters or air conditioners. Never press the PTT button before connecting the antenna to the radio.

### **Wiring Methods**

There are two possible wiring configurations for connecting to the vehicles power supply.

#### **A. Radio stays ON when the ignition is switched OFF**

Connect the radio's negative (black) lead to the vehicle chassis, or directly to the battery's negative terminal.

Connect the radio's positive (red) lead via the 3 Amp fuse to the battery's positive terminal. Alternatively, the positive lead could be connected at the fuse box at a point that has DC Power continuously available (preferably the battery side of the ignition switch) via the 3 Amp fuse.

#### **B. Radio turns OFF with the ignition switch**

Connect the radio's negative (black) lead to the vehicle's chassis, or directly to the battery's negative terminal.

The radios positive (red) lead should connect to an accessory point in the vehicle's fuse box via the 3 Amp fuse.

## Antenna information

The antenna (not supplied) is of critical importance to maximise your output power and receiver sensitivity.

A poorly installed, inferior quality antenna, or one not designed for the correct frequency band, will give poor performance. You should only purchase an antenna designed for the 477MHz frequency band.

## Antenna installation

1. This radio is fitted with a NEW small FME type antenna connector. If this is not compatible with your existing antenna connection, please contact Oricom to purchase an adaptor. (Part Number: 2U0159)
2. To obtain maximum performance from the radio, select a high quality antenna and mount it in a good location.

**Never press the PTT before connecting the antenna to the radio.**

## Optional accessories

If required, you may install an external (8 ohm, Minimum 5W power) speaker fitted with a 3.5mm plug (not supplied).

Depending on the installation, it may be necessary to use an external speaker (not supplied) to give improved volume and clarity. This can be plugged into the external speaker (SP) socket on the rear of the unit.

## Operations

### Turning on the Power

Press and hold the Channel selector.

At power on, the current applied DC voltage is displayed numerically as shown below.

Special over and under voltage detection circuitry protects the radio and warns of excessive voltage conditions by the LCD flashing the 3 backlight colours.

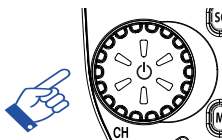

### Setting the Volume

Turn the channel selector clockwise to adjust the sound level for comfortable reception.

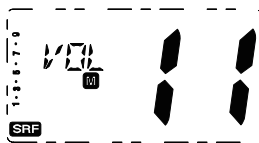
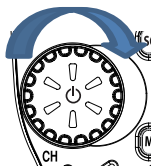

## Selecting a channel

Press channel selector once. "CH" will appear on the LCD. Select the channel by rotating the channel knob.

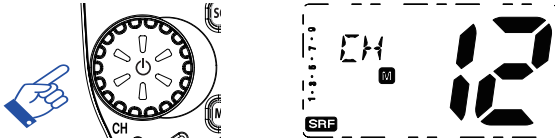

## Setting the Squelch Level

1. Press channel selector 2 times. The current squelch level is displayed.
2. Select the squelch level by rotating the channel knob.

The radio has 16 preset (off to 15) squelch levels, off-Squelch open.

1 - Max. sensitivity (Min. squelch)

15 - Min. sensitivity (Max/Tight squelch)

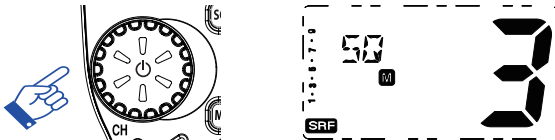

Note : \* If a button is not pressed within 5 seconds, the radio will automatically exit the sub display of "VOL" "CH" and "SQL".

### PTT (Push-To-Talk) button

Pressing the PTT allows audio to be transmitted, by speaking across the front of the controller speaker microphone.

TX is indicated by the level bars on the LCD display. To receive, release the PTT button and then TX will disappear on the display.

When transmitting, hold the MIC 5 cm from your mouth and speak clearly in normal voice across the front of the mic.

### Scanning

The Scan feature allows you to search for active channels automatically.

There are two scanning modes: Open Scan and Priority Scan. Both of these scan modes can be set from the menu.

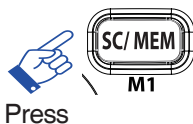

### Open scan

Press Scan/Menu button and scanning starts. The OS sub menu display appears on the LCD.

The scan direction can be changed at any time by rotating the channel selector left or right.

To stop Scan, press Scan/Menu Button or PTT button.

When a signal is found, scanning will stop at that channel to allow the signal to be heard, then resume scanning when the channel is clear again.

CH 1-2-3-4-5-6-7 ..... 77-78-79-80

## Priority scan

With Priority Scan, the radio scans for activity, but in addition, it also inserts your Priority Channel into the scan sequence.

This means that your Priority Channel will be monitored regularly while scanning to ensure that no calls are missed. Any signal received on your Priority Channel will take precedence over any signals received on the other channels.

CH 1-2-3-4-5- PRI CH - 6-7-8-9-10- PRI CH ..... 76-77-78-79-80

## Memory On/Off

Your UHF390P has been pre-programmed with all the UHF CB channels into the Open Scan channel memory.

However, you can change or customize the channels by this function.

- Select the desired channel with rotary knob.
- Press and hold SC/MEM button.
- The memory icon “M” disappears.



Press  
and hold

## Priority channel Recall

You can store a priority channel through the menu in the “PRI” setting.

To recall the priority channel press the PRI/LOC button.

“PRI” will appear along with the priority channel number.

This priority channel will also be automatically monitored during Priority Scan.

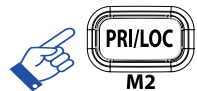

Press

## Key Lock

To prevent accidental entries, you can lock the key pad.

To enable “Key lock” Function:

- Press hold “PRI/LOC” button. “LOC ON” will then appear.

When the key lock is active, a warning beep will be heard if you attempt to press keys.

Note: The PTT, volume / channel / squelch dial do not lock. Warning beep is only active if beep function is turned on.

- To disable the Key lock function:
- Press hold “PRI/LOC” button. “LOC OF” will then appear.

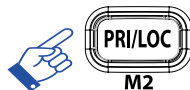

Press  
and hold

## Monitor Function

The monitor button is used to temporarily open the squelch, in order to listen to signals that are too weak to keep the squelch permanently opened.

For brief listening, press Monitor briefly to turn Squelch off, press briefly again to turn Squelch back on.

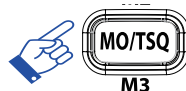

Press

## Selecting the Required CTCSS or DCS Tone

To pre-select the CTCSS tone or DCS on your radio, please refer to the MENU setting.

## Enabling CTCSS or DCS on a Channel

If a CTCSS tone has been selected, it can be enabled on individual channels.

1. Rotate the Channel knob to select the required channel. The letters CT or DT icon will appear.
2. Press and hold the MO/TSQ button.

## Disabling CTCSS or DCS on a Channel

Repeat steps 1 and 2 above.

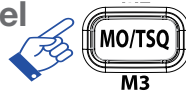

Press  
and hold



## Triple Watch Function

Pressing the TW/MENU button activates the Triple watch function.

The Triple Watch feature allows for monitoring of 2 or 3 channels.

The currently displayed channel and 2 more channels saved in TRI1 and TRI2.

To store the channels in TRI1 or TRI2, select the channels and features CTCSS/DCS/Duplex on the display, then enter menu mode and save the channel in TRI1 or TRI2.

If only one additional channel is required, then select “Off” in TRI2.

Once Watch is activated, by pressing the TW/MENU button, the TRI 1 and TRI 2 channels are checked in the following sequence: Main channel is checked for 0.7 of a second, then TRI 1 for 0.15 seconds, TRI 2 FOR 0.15 seconds and then back to the Main channel.

The sequence is repeated until a signal is detected or radio is switched off. If there is a signal present on TRI 1 or TRI 2, the radio will wait on that channel for 5 seconds after the signal is no longer present, then revert to Tri Watch operation.



Triple Watch can be disabled by pressing any keys.

## Memory recall channels

To access memorized channels simply press the “MR/MW” button then one of the M1 to M4 buttons.

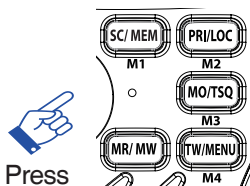

The default channels of M1 to M4

M1 : 1 channel

M2 : 20 channels

M3 : 40 channels

M4 : 80 channels

### Memory write channels

The Memory write button is used to store a channel in the memory locations M1 to M4.

To store channels:

- Select the desired channel with rotary knob.
- Press and hold MR/MW button.
- Select the location you would like to store the channel by pressing M1, M2, M3 or M4.



Press  
and hold

### Memory scan

- Press SC/MEM button to start scanning.
- Whilst radio is in scan mode, push and hold the SC/MEM button for 2 seconds, the radio will now start scanning the stored channels in M1, M2, M3 and M4.
- When you want to stop scanning, you can press the SC/MEM button or push the PTT button.

### Menu Function

The Menu function provides a convenient method of customizing some of the radios functions.

The following menu options are available:

Note that some items are only available on certain channels.

To access the Menu functions:





1. Press and hold the TW/MENU button. The first menu function is displayed.
2. Briefly press the menu button to cycle through each available function.  
After the last function has been selected, the cycle automatically exits the menu.
3. Use the volume control to change the parameters of the selected function.

4. To exit the menu, press PTT button or press and hold the menu button for 2 seconds.

The following features can be selected by using the “MENU” button:

- 1) User selectable 38 CTCSS and 104 DCS codes (CTCSS or DCS cannot be enabled on channels 5 or 35)
- 2) Scrambler setting (Off, 1 to 5 different frequencies)
- 3) LCD backlight colour (3 colours)
- 4) LCD backlight level (Bright or Dim)
- 5) Voice enhancer equalizer setting (-5 to +5, 10 steps)
- 6) Duplex On/Off
- 7) Priority channel memory ( 1 to 80 Channel)
- 8) Scan mode (Open or priority scan)
- 9) Busy channel lockout (On or Off)
- 10) Key beep tone (On or Off)
- 11) Roger beep tone (On or Off)
- 12) Triple watch sub channel 1 setting
- 13) Triple watch sub channel 2 setting
- 14) Squelch tail (On or Off)
- 15) Auto power off 1 ,2 or 4 hours
- 16) Software version display

Function	Parameter	Display	Default
CTCSS and DCS	CTCSS 38		CTCSS 01
	DCS 104		
Scrambler	1		Off
	Off		
	5		
Backlight LED colour	YE		Green
	Green		
	Ab		
Bright of LCD	br		Bright
	dr		
Voice equalizer	+5		0
	0		
	-5		
Duplex	On		Off
	Off		
Priority CH.	1		11
	11		
	80		
Scan mode	OS		OS
	PS		
Busy channel lock	On		Off
	Off		
Key beep tone	On		Off
	Off		
Roger beep tone	On		Off
	Off		

Triple watch CH 1	1		Off
	80		
Triple watch CH 2	1		Off
	80		
Squelch tail	On		Off
	Off		
Auto power off	Off		Off
	1		
	2		
	4		
Software Version	Version		Ver. 01

## Duplex

### General

Your radio has a Repeater Access function to allow use of local repeater station (if available in your area). Repeaters are shared radio systems installed by interested parties (clubs, local business etc.) that pick transmissions on specific channels and re-transmit (or repeat) the received signal to another channel.

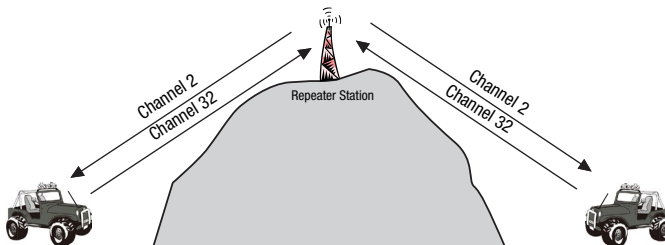

The Repeater Access function can be set (from channel 1 to 8 and 41 to 48) used by local repeater stations. When activated, your radio will receive the Repeater on its specific channel (all repeater outputs are on channel 1 to 8 and 41 to 48) but transmit to the repeater channel 31 to 38 and 71 to 78 (Factory default is set to On for all repeater channels).

e.g.

CH01 on Duplex mode will receive on CH01 but transmit on CH31.

CH02 on duplex mode will receive on CH02 but transmit on CH32.

If you transmit on CH01 duplex mode, you are actually transmitting on CH31; the repeater station down converts your signal and retransmits on CH01.

Your transceiver allows you to pre-select Duplex operation individually on each channel.

CH and Number	Simplex mode Transmit/ Receiver Frequency (MHz)	Duplex Mode Transmit/ Receiver Frequency(MHz)
1	476.425	477.175 CH31
2	476.450	477.200 CH32
3	476.475	477.225 CH33
4	476.500	477.250 CH34
5	476.525	477.275 CH35
6	476.550	477.300 CH36
7	476.575	477.325 CH37
8	476.600	477.350 CH38
41	476.4375	477.1875 CH71
42	476.4625	477.2125 CH72
43	476.4875	477.2375 CH73
44	476.5125	477.2625 CH74
45	467.5375	477.2875 CH75
46	476.5625	477.3125 CH76
47	476.5875	477.3375 CH77
48	476.6125	477.3625 CH78

For this example, we are adopting CH01 as the repeater channel.

## **CTCSS and DCS Setting**

This feature allows you to receive signals only from callers who have selected the same CTCSS and DCS code. DCS is similar to CTCSS. It provides 104 extra, digitally coded, squelch codes that follow after the 38 CTCSS codes. CTCSS 1 - 38, followed by DCS 1 - 104.

## **Scramble**

Scramble enables private communications by scrambling the voice signal. This prevents users without descrambler equipment or a compatible unit from understanding the conversation.

Select desired channel. SCR appears when scramble is turned on in the menu. You can select 1 to 5.

## **3 Multi Colour backlight**

You can select from 3 different colours for the LCD backlight.

## **LCD Backlight Brightness**

You can reduce the brightness of the LCD backlight to be more comfortable while driving at night.

## Voice Enhancer Equalizer

Choose from 10 different receive audio level settings to provide a natural voice enhancer for super clarity and performance.

The radio has 10 preset (-5 to 5) voice enhancer equalizer levels.

-5 : Bass - Enhancing the low frequencies, the sound quality becomes mild and easy to listening.

0 : Normal.

+5 : Treble - Enhancing the high frequencies, the sound quality becomes sharp.

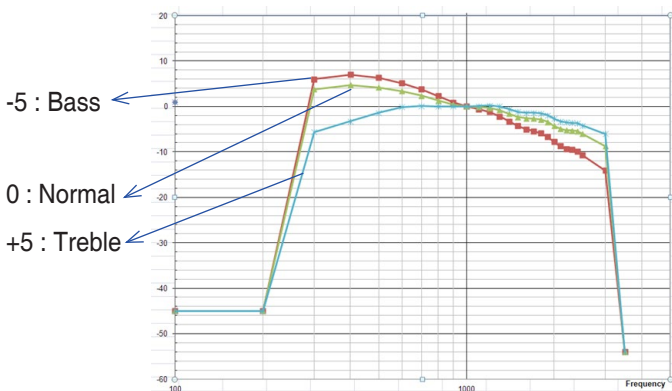

## Duplex

Duplex mode can be turned on or off on the duplex channels.

When turned on, the transmit channel will be as shown in the table on page 21.

## Priority Channel Set

A priority channel can be stored in the menu.

The letter “PRI” will appear when the selected channel is set to Priority. This channel will then be automatically monitored during the Priority Scan.

Note: You can only store one channel as your priority channel.



## Scanning

The UHF390P has two types of scanning: Open scanning (OS) and Priority scanning (PS).

Scanning allows you to search for active channels programmed in the memory.

You can choose Scan type in menu mode.

To initiate scanning:

Press scan key and scanning starts. OS icon appears during scanning.

## Open Scan (OS) Mode

The Open Scan feature scans for activity on all CB channels in memory. Once a channel is located, scanning will pause. This will allow the signal to be heard.

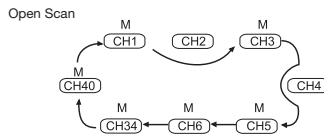

## Priority Scan (PS) Mode

With Priority Scan, the radio scans for activity, but in addition, it also inserts your Priority Channel into the scan sequence.

This means that your Priority Channel will be monitored regularly while scanning to ensure that no calls are missed. Any signal received on your Priority Channel will take precedence over any signals received on the other channels.

The priority channel will be checked after every 4th channel scanned.

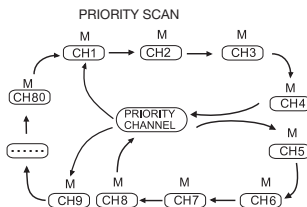

### **Busy Channel Lock**

If the channel is already in use, you can prevent the UHF CB radio from transmitting. This is particularly important when using CTCSS/DCS.

### **Key Beep**

The Beep tone emits a tone when you press any of the buttons on the controller speaker microphone (except PTT button).

### **Roger Beep**

This function emits a beep on the communication party to inform that the transmission is finished.

### **Squelch Tail**

Squelch tail is the noise heard after the transmitting party releases the PTT and is heard by the receiving party.

If Squelch Tail is turned ON, on both radios this squelch noise will be muted.

### **Auto Power Off**

This feature allows the radio to be connected directly to the battery of a vehicle and when enabled, will automatically turn the radio off, if it has not been used for a preset period of time 1, 2 or 4 hours. The main purpose of this feature is if the radio is inadvertently left on when directly connected to the battery it automatically turns the radio off to prevent the battery from being discharged.

## Factory Reset

If the radio's display locks up or stops functioning properly, you might need to reset your UHF radio.

Caution: This procedure clears all the information you have stored in your UHF radio.

Before you reset your UHF radio, try turning it off and on again.

If your UHF radio is still not functioning correctly, you may need to reset the UHF radio.

To reset, press and hold monitor button and power on. "Reset" will appear in the display. The radio will then return to standby mode.

## TOT (Time Of Timer)

Australian and New Zealand standards require that if the PTT is pressed for more than 3 minutes, the unit must stop transmitting. The radio is set to stop transmitting after 2 minutes and 30 seconds of continuous transmission. "TOT-on" will appear in the display and it will emit a beep sound to indicate that TOP is activated.

## Channel Frequency Table

### Radiocommunications (Citizen Band Radio Stations) Class Licence 2002

No licence is required to own or operate this radio in Australia and New Zealand. The Radiocommunications (Citizen Band Radio Stations) Class Licence 2002 contains the technical parameters, operating requirements, conditions of licence and relevant standards for Citizen Band (CB) radios. CB radios must comply with the class licence for their use to be authorised under the class licence.

### UHF channels and frequencies

IMPORTANT NOTE: The operation of your UHF radio in Australia and New Zealand is subject to conditions in the following licenses:

In Australia the ACMA Radio communications (Citizen Band Radio Stations) and in New Zealand by MED the General User Radio License for Citizen Band Radio.

Channel		Tx	Rx	Channel		Tx	Rx
		Freq MHz	Freq MHz			Freq MHz	Freq MHz
01*		476.4250	476.4250	21		476.9250	476.9250
	41*	-	476.4375		61‡	—	—
02*		476.4500	476.4500	22†		476.9500	476.9500
	42*	-	476.4625		62‡	—	—
03*		476.4750	476.4750	23†		476.9750	476.9750
	43*	-	476.4875		63‡	—	—
04*		476.5000	476.5000	24		477.0000	477.0000
	44*	-	476.5125		64	477.0125	477.0125
05*		476.5250	476.5250	25		477.0250	477.0250
	45*	-	476.5375		65	477.0375	477.0375
06*		476.5500	476.5500	26		477.0500	477.0500
	46*	-	476.5625		66	477.0625	477.0625
07*		476.5750	476.5750	27		477.0750	477.0750
	47*	-	476.5875		67	477.0875	477.0875
08*		476.6000	476.6000	28		477.1000	477.1000
	48*	-	476.6125		68	477.1125	477.1125
9		476.6250	476.6250	29		477.1250	477.1250
	49	476.6375	476.6375		69	477.1375	477.1375
10		476.6500	476.6500	30		477.1500	477.1500
	50	476.6625	476.6625		70	477.1625	477.1625
11		476.6750	476.6750	31*		477.1750	477.1750

## UHF CB channels and frequencies

	51	476.6875	476.6875		71*	477.1875	-
12		476.7000	476.7000	32*		477.2000	477.2000
	52	476.7125	476.7125		72*	477.2125	-
13		476.7250	476.7250	33*		477.2250	477.2250
	53	476.7375	476.7375		73*	477.2375	-
14		476.7500	476.7500	34*		477.2500	477.2500
	54	476.7625	476.7625		74*	477.2625	-
15		476.7750	476.7750	35*		477.2750	477.2750
	55	476.7875	476.7875		75*	477.2875	-
16		476.8000	476.8000	36*		477.3000	477.3000
	56	476.8125	476.8125		76*	477.3125	-
17		476.8250	476.8250	37*		477.3250	477.3250
	57	476.8375	476.8375		77*	477.3375	-
18		476.8500	476.8500	38*		477.3500	477.3500
	58	476.8625	476.8625		78*	477.3625	-
19		476.8750	476.8750	39		477.3750	477.3750
	59	476.8875	476.8875		79	477.3875	477.3875
20		476.9000	476.9000	40		477.4000	477.4000
	60	476.9125	476.9125		80	477.4125	477.4125

\* The primary use for these channels is repeater operation using 750 kHz offset.

Channels 1-8 and 41-48 inclusive are used for mobile reception and channels 31-38 and 71-78 for mobile transmission. In addition, any designated repeater channel may be used for simplex operation in areas where it is not used for repeater operation.

† Speech telephony is prohibited on these channels.

‡ At the time of production Channels 61, 62 and 63 are guard channels and are not available for use.

Channel 5 and 35 (paired for Duplex repeaters) are reserved as emergency channels and should be used only in an emergency.

CTCSS and DCS will not operate on channels 5 and 35.

A list of currently authorised channels can be obtained from the ACMA website in Australia and the MED website in New Zealand. Channel 11 is a calling channel generally used to call others and channel 40 is the customary road vehicle channel.

Once contact is established on the calling channel, both stations should move to another unused "SIMPLEX" channel to allow others to use the calling channel.

Channels 22 and 23 are for Telemetry and Telecommand use, voice communications are not allowed on these channels.

Channel 9 and above are the best choices for general use in Simplex mode.

**38 CTCSS CODE LIST**

CODE	Frequency(Hz)	CODE	Frequency(Hz)
OFF	OFF	20	131.8
1	67.0	21	136.5
2	71.9	22	141.3
3	74.4	23	146.2
4	77.0	24	151.4
5	79.7	25	156.7
6	82.5	26	162.2
7	85.4	27	167.9
8	88.5	28	173.8
9	91.5	29	179.9
10	94.8	30	186.2
11	97.4	31	192.8
12	100.0	32	203.5
13	103.5	33	210.7
14	107.2	34	218.1
15	110.9	35	225.7
16	114.8	36	233.6
17	118.8	37	241.8
18	123.0	38	250.3
19	127.3		

## DCS codes table

Code No.	DCS Code (Octal)	Code No.	DCS Code (Octal)	Code No.	DCS Code (Octal)
1	023	36	223	71	445
2	025	37	225	72	446
3	026	38	226	73	452
4	031	39	243	74	454
5	032	40	244	75	455
6	036	41	245	76	462
7	043	42	246	77	464
8	047	43	251	78	465
9	051	44	252	79	466
10	053	45	255	80	503
11	054	46	261	81	506
12	065	47	263	82	516
13	071	48	265	83	523
14	072	49	266	84	526
15	073	50	271	85	532
16	074	51	274	86	546
17	114	52	306	87	565
18	115	53	311	88	606
19	116	54	315	89	612
20	122	55	325	90	624
21	125	56	331	91	627
22	131	57	332	92	631
23	132	58	343	93	632
24	134	59	346	94	654
25	143	60	351	95	662
26	145	61	356	96	664
27	152	62	364	97	703
28	155	63	365	98	712
29	156	64	371	99	723
30	162	65	411	100 (A0)	731
31	165	66	412	101 (A1)	732
32	172	67	413	102 (A2)	734
33	174	68	423	103 (A3)	743
34	205	69	431	104 (A4)	754
35	212	70	432		

### **Express Warranty (Australia)**

This Express Warranty is provided by Oricom International Pty Ltd ABN 46 086 116 369, Unit 1, 4 Sovereign Place, South Windsor NSW 2756, herein after referred to as "Oricom".

Oricom warrants that the product is free from defects in materials or workmanship during the Express Warranty Period. This Express Warranty does not extend to any product from which the serial number has been removed or was purchased outside of Australia.

The benefits of this Express Warranty are in addition to other rights and remedies you may have under the Australian Consumer Law. Our goods come with guarantees that cannot be excluded under the Australian Consumer Law. You are entitled to a replacement or refund for a major failure and compensation for any other reasonably foreseeable loss or damage. You are also entitled to have the goods repaired or replaced if the goods fail to be of acceptable quality and the failure does not amount to a major failure. In the event of a minor failure, Oricom reserves the right to choose to repair or replace the product.

The Express Warranty Period will be a period of 5 years beginning on the date of purchase of the product evidenced by your dated sales receipt. You are required to provide proof of purchase as a condition of receiving Express Warranty services.

You are entitled to a replacement product or repair of the product at our discretion according to the terms and conditions of this document if your product is found to be faulty within the Express Warranty Period. This Express Warranty extends to the original purchaser only and is not transferable.

Products distributed by Oricom are manufactured using new materials or new and used materials equivalent to new in performance and reliability. Spare parts may be new or equivalent to new. Spare parts are warranted to be free from defects in material or workmanship for thirty (30) days or for the remainder of the Express Warranty Period of the Oricom branded product in which they are installed, whichever is longer. During the Express Warranty Period, Oricom will where possible repair and if not replace the faulty product or part thereof. All component parts removed under this Express Warranty become the property of Oricom. In the unlikely event that your Oricom product has a recurring failure, Oricom may always,



subject to the Competition and Consumer Act 2010, at its discretion, elect to provide you with a replacement product of its choosing that is at least equivalent to your product in performance.

No change to the conditions of this Express Warranty is valid unless it is made in writing and signed by an authorised representative of Oricom.

Oricom will not be liable under this Express Warranty, and to the extent permitted by law will not be liable for any defect, loss, damage or injury arising out of or in connection with a:

1. Failure by you to adhere to the warnings and follow the instructions set out in this user guide for the proper installation and use of the product;
2. Willful misconduct or deliberate misuse by you of the product;
3. Any external cause beyond our control, including but not limited to power failure, lightning or over voltage; or
4. Modification to the product or services carried out on the product by anyone other than Oricom or Oricom's authorised service provider.

### **How to make a claim under your Express Warranty in Australia**

Oricom has a simple warranty process for you to follow:

- Please call or email our Customer Support Team, 02 4574 8888 or support@oricom.com.au.
- A Customer Support Team member will verify after troubleshooting with you if your product qualifies under warranty. If so, they will give you a Product Return Authorisation number.
- We will then email a Return Authorisation form and a Repair Notice (if necessary), together with instructions on how to return the product for warranty service.

Please note that if a Customer Support Team member advises that your product does not qualify for return, this warranty does not apply to your product. Products that are authorised to be returned to Oricom in Australia must include all of the following:

- A completed Return Authorisation form
- A copy of your Proof of Purchase (please keep your original copy)
- The faulty product, including all accessories.

Send the approved returns to:

Oricom International Pty Ltd  
Locked Bag 658  
South Windsor NSW 2756 Australia

Please note that this Express Warranty excludes expenses incurred by you in returning any faulty product to us. You must arrange and pay any expenses incurred (including postage, delivery, freight, transportation or insurance of the product) to return the faulty product to us, however, we will arrange delivery of the repaired or replaced faulty product to you.

## **Important Information**

### **Repair Notice**

Please be aware that the repair of your products may result in the loss of any user-generated data (such as stored telephone numbers, text messages and contact information). Please ensure that you have made a copy of any data saved on your product before sending for repair. Please also be aware that products presented for repair may be replaced by refurbished products or parts of the same type rather than being repaired.

# ORICOM CUSTOMER SUPPORT

Oricom have a trained and dedicated team of Customer Support Representatives, each with the knowledge and resources to assist in answering your questions quickly and efficiently.

## **Oricom Support - Australia**

For all product enquiries, troubleshooting or to discuss the range of Oricom products, feel free to contact Oricom or visit our website for answers to frequently asked questions.

**(02) 4574 8888**

Monday - Friday 8am – 6pm AEST

Email: [support@oricom.com.au](mailto:support@oricom.com.au)

[www.oricom.com.au](http://www.oricom.com.au)

## **Oricom Support - New Zealand**

**0800 674 266**

Monday - Friday 10am - 8pm NZST

Email: [support@oricom.co.nz](mailto:support@oricom.co.nz)

