

HARDKORR™

USER MANUAL



*Regulator included with
HKP200SOL only

200W HEAVY DUTY SOLAR MAT WITH 15A SOLAR REGULATOR *MK II*

HKP200SOL / HKP200SOLNR

V2.0 - 5.2024

CONGRATULATIONS ON PURCHASING THIS HIGH QUALITY HARDKORR PRODUCT!

In doing so, you now have the assurance and peace of mind that comes from purchasing a product manufactured to the highest quality standards.

Our aim is for you to be completely satisfied with your purchase, and therefore your new Hardkorr product is backed by a comprehensive warranty and an outstanding after-sales customer service team.

We hope you will enjoy using this product for many years to come.

If you require technical support, or in the unlikely event your purchase appears to be faulty, please contact our support team for immediate assistance. Contact details for each country are contained within this user guide.

- THE HARDKORR TEAM

CONTENTS

SAFETY INSTRUCTIONS	1
OVERVIEW	2
SPECIFICATIONS	3
INSTALLATION	5
OPERATION	13
TROUBLESHOOTING	16
FREQUENTLY ASKED QUESTIONS	18
WARRANTY INFORMATION	19

DISCLAIMER

While caution has been taken to ensure the accuracy of the contents of this guide, Hardkorr assumes no responsibility for errors or omissions. Please note that specifications and product functionality may change without notice.

For assistance with assembly or installation, parts and service, please visit www.hardkorr.com or contact customer service through the following:



Toll Free:

1800 533 544

Monday - Friday

9AM - 4PM (AEST)



Language spoken: English

support@hardkorr.com

IMPORTANT, RETAIN FOR FUTURE REFERENCE: READ CAREFULLY

- RISK OF FIRE, EXPLOSION AND BURNS:**
 Working in the vicinity of lead acid batteries is dangerous. Explosive gases can develop during normal battery operation. Be certain there is enough ventilation to release the gasses. Do not smoke when in the vicinity of the battery under charge.
- Ensure the red is connected to the positive terminal and the black is connected to the negative terminal if using clamps to connect to your battery. Connecting to the wrong terminals may burn out the regulator.
- Do not use the regulator to charge non-rechargeable batteries; this may result in harm to the user and/or damage to the equipment.
- Check the manufacturer's data for your battery and ensure the maximum voltage of the profile you select does not exceed the recommended maximum charge voltage.
- Confirm that the plugs are tightly connected to avoid excessive heating from a loose connection.
- Be careful not to short-circuit the battery connections.
- Accidental shorting of the terminals or wiring can result in sparks, causing personal injury or a fire hazard. We recommend that you cover up the panel with a soft cloth during installation of the regulator to block all incoming light. This will ensure that no damage is caused to the solar panel or battery if the wires are accidentally short-circuited.
- The regulator should not be used by children or persons with reduced physical, sensory or mental capabilities, or lack of experience and knowledge, unless they are supervised or have been instructed on how to use the appliance by a person responsible for their safety.
- Do not alter or disassemble the solar regulator under any circumstances. Incorrect handling or reassembly may result in a risk of electric shock or fire and may void the unit warranty.
- Minimum cable gauge is dependent on the total cable length between the solar panel and battery. Selecting the wrong cable or fuse size could result in harm to the installer or user and/or damage to the battery or other equipment installed in the system. The installer is responsible for ensuring that the correct cable and fuse sizes are used when installing this solar regulator.
- This product is designed to operate in ambient temperatures between -40°C and 85°C . Do not operate outside of this temperature range. Do not use this product to charge a frozen battery. Discontinue use if battery becomes excessively warm.
- Only use this solar regulator for charging 12V lithium, AGM, wet, gel and calcium batteries.

REGULATOR OVERVIEW

Layout applies to all In-Line Smart Solar Regulator models.

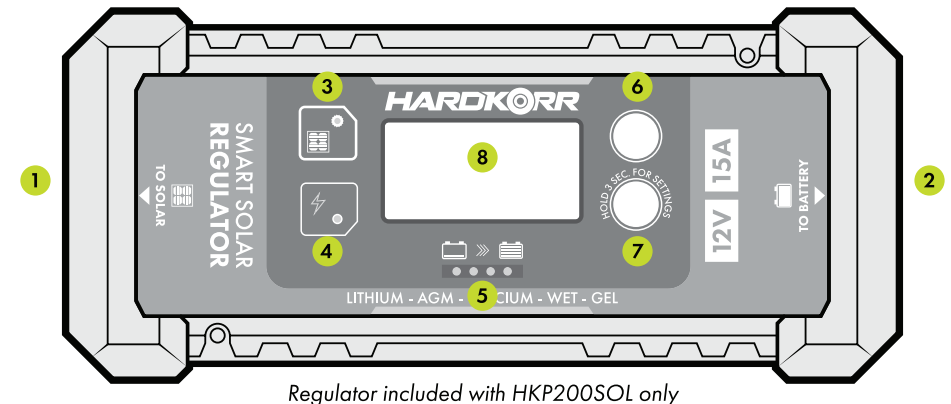

Regulator included with HKP200SOL only

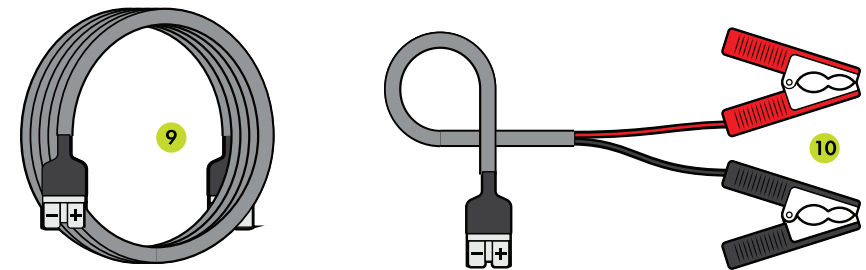

1	Solar panel input (Anderson-style plug)	6	Display units (A/V) mode selection
2	Battery output (Anderson-style plug)	7	Battery type selection button
3	Solar power indicator LED	8	LCD Display
4	Battery charging indicator LED	9	6m Anderson-style extension cable
5	Battery charge mode indicator LEDs	10	Alligator clamps

SOLAR REGULATOR SPECIFICATIONS

SPECIFICATIONS	15A SOLAR REGULATOR
RATED MAXIMUM CURRENT	15A
INPUT VOLTAGE	15-22V
LOWEST OPERATING VOLTAGE	8V
STANDBY CONSUMPTION	5mA
MAX VOLTAGE DROP	0.25V
START CHARGING VOLTAGE	3V
VOLTAGE CONTROL ACCURACY	± 1%
BATTERY TEMPERATURE COMPENSATION CO-EFFICIENT	-24mV/°C
TEMP COMPENSATION RANGE	-20°C ~ 50°C
INPUT/OUTPUT TERMINALS	50A Anderson connector
MATERIALS	ABS plastic
INGRESS PROTECTION	IP65
OPERATING TEMPERATURE	-25°C to 50°C
STORAGE TEMPERATURE	-40°C to 85°C
OPERATING HUMIDITY RANGE	0% to 100%
DIMENSIONS	195mm x 83mm x 46mm
WEIGHT	0.3kg
PROTECTION CIRCUITS	Reverse polarity protection, short circuit protection, reverse current protection, overcharge protection, transient overvoltage protection, over-temperature protection

SOLAR MAT SPECIFICATIONS

SPECIFICATIONS	HKP200SOL	HKP200SOLNR
CELL TYPE	A-grade monocrystalline silicon	
CELL EFFICIENCY	22.5%	
CELL BACKING	Solid copper	
CELL COATING	Crocskin® cell armour	
CANVAS	1680D Ballistic nylon	
WATTAGE	200W	
WORKING MAX VOLTAGE	20.0V	
WORKING MAX CURRENT	12.6A	
OPEN CIRCUIT VOLTAGE	23.6V	
SHORT CIRCUIT VOLTAGE	13.7A	
INGRESS PROTECTION	IP64 - splash/rainproof	
OPERATING TEMPERATURE	-40°C –85°C	
DIMENSIONS (FOLDED)	580mm x 560mm x 40mm	
DIMENSIONS (UNFOLDED)	2515mm x 575mm	
WEIGHT *exc. regulator, cables & bag	7.2kg	
WEIGHT *with all inclusions	9.9kg	9.5kg
CERTIFICATIONS	CE, RoHS, TUV (IEC-61730, IEC-61215)	

YOU WILL NEED:

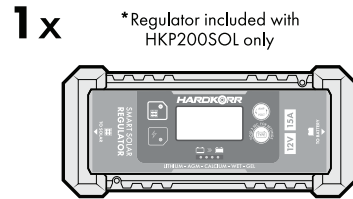
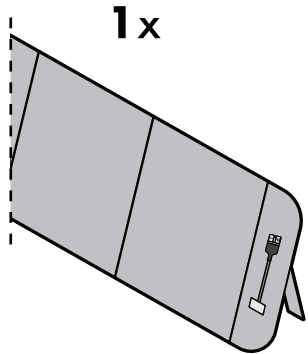

ENSURE YOUR REGULATOR IS SIZED TO SUIT. A COMPATIBLE DC-DC MAY ALSO BE SUITABLE.

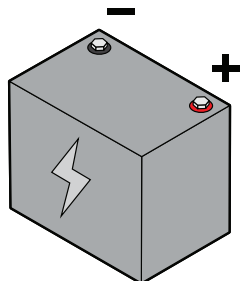
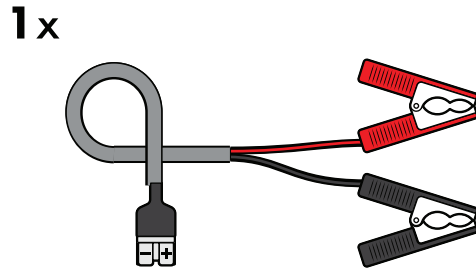
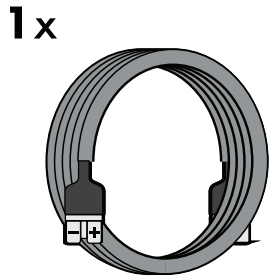

BATTERY NOT INCLUDED

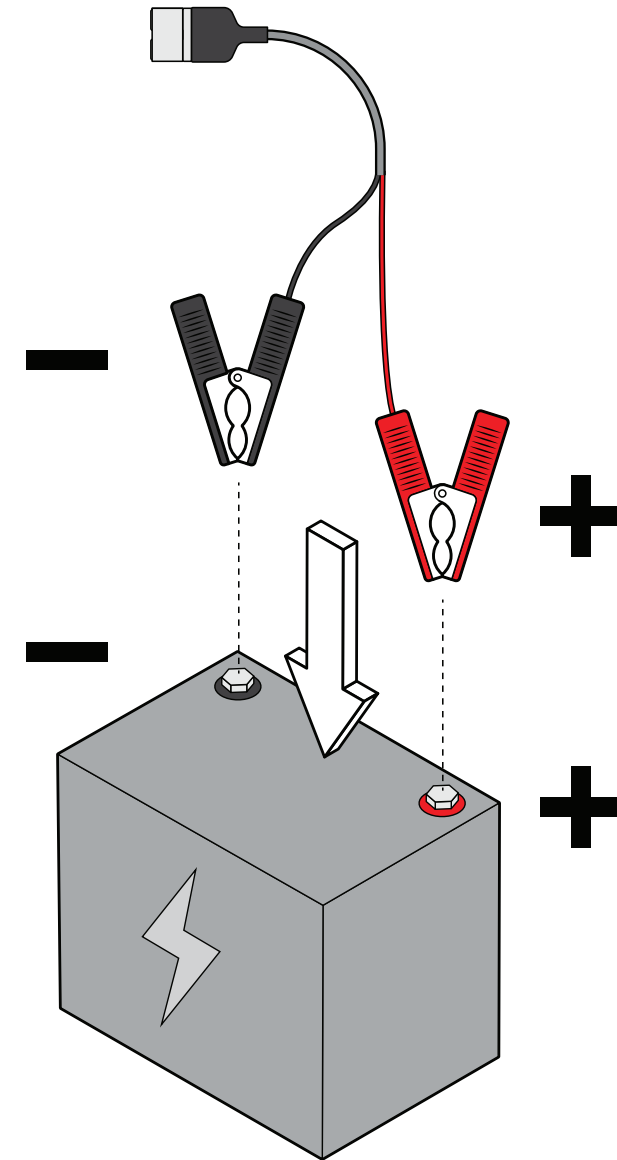

1

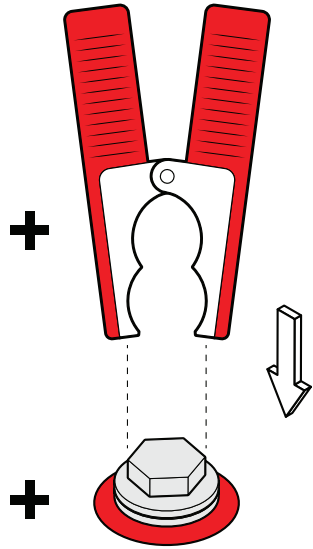

2

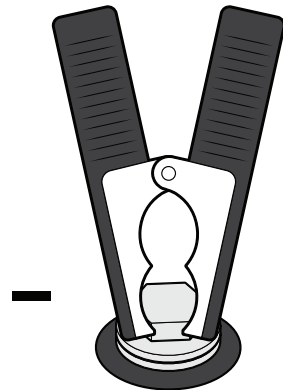
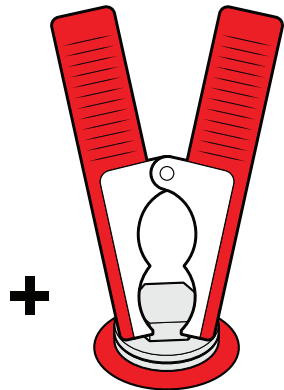
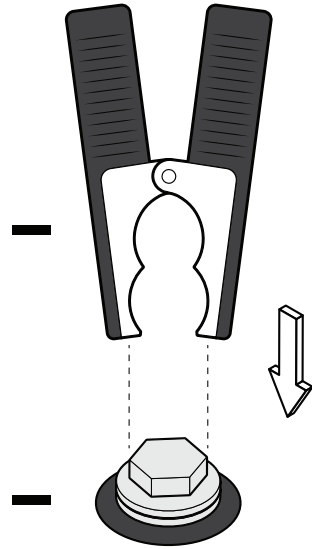

3

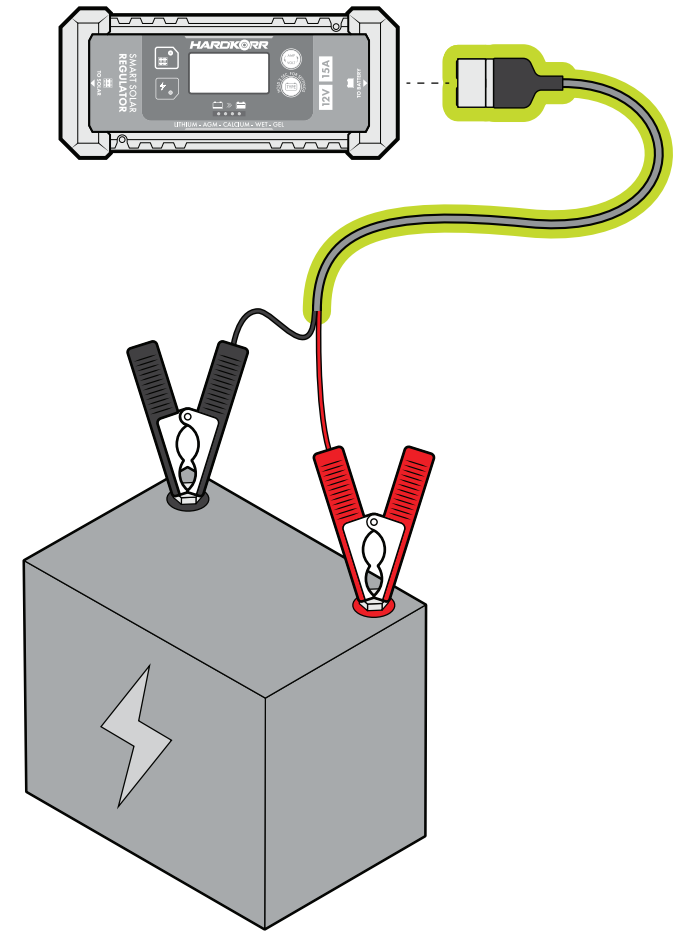

4

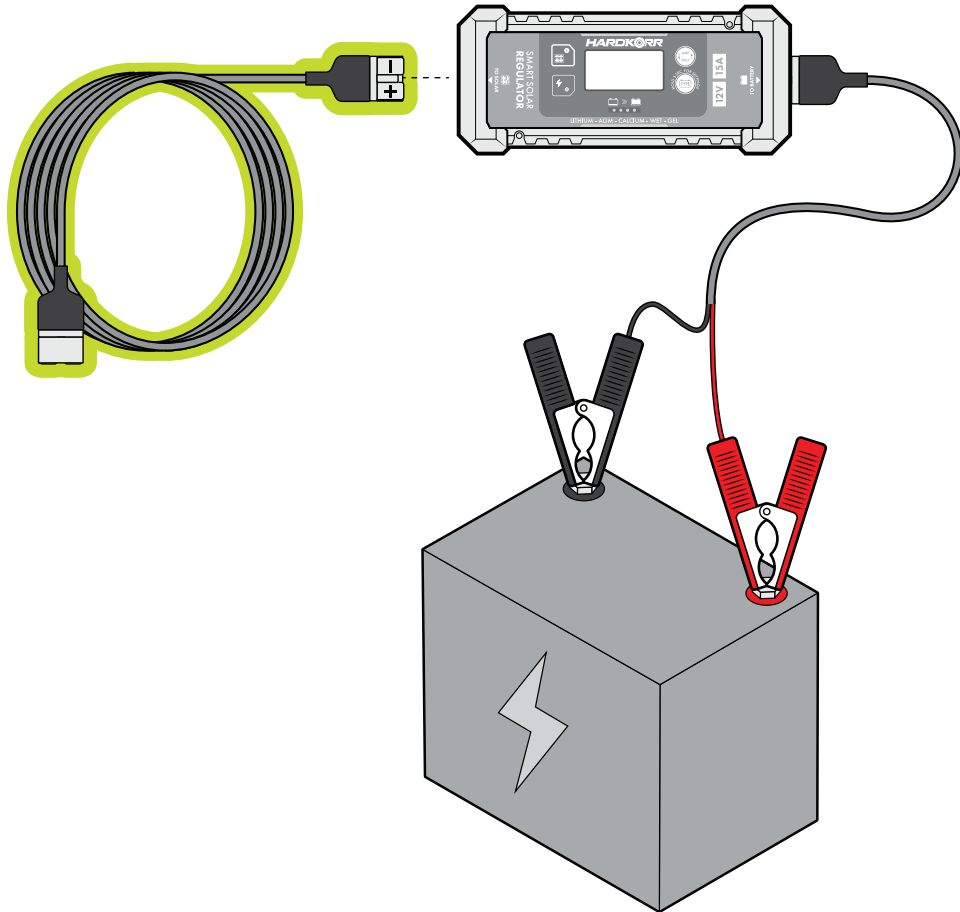

5

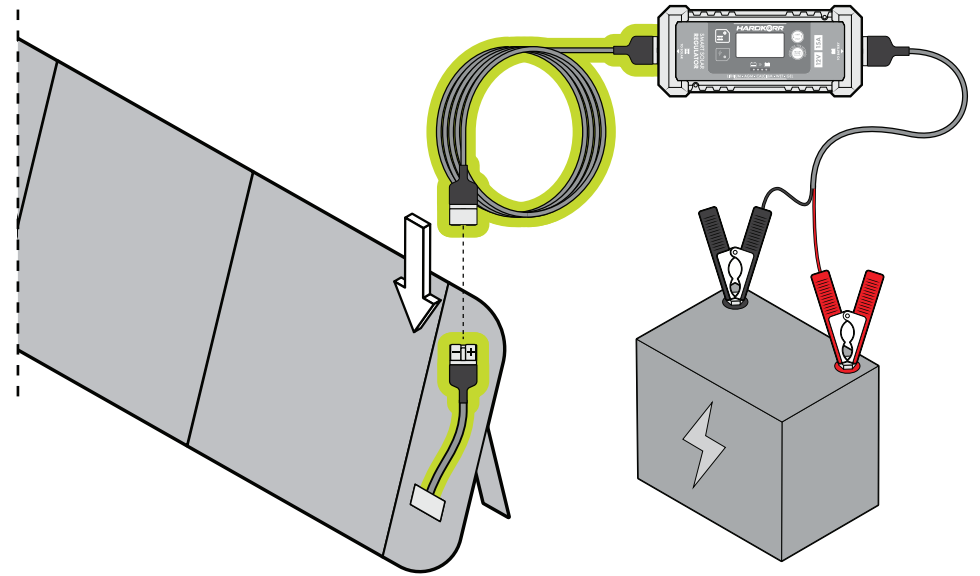

**IF DISPLAY DOES NOT
TURN ON, CHECK CONNECTIONS.**

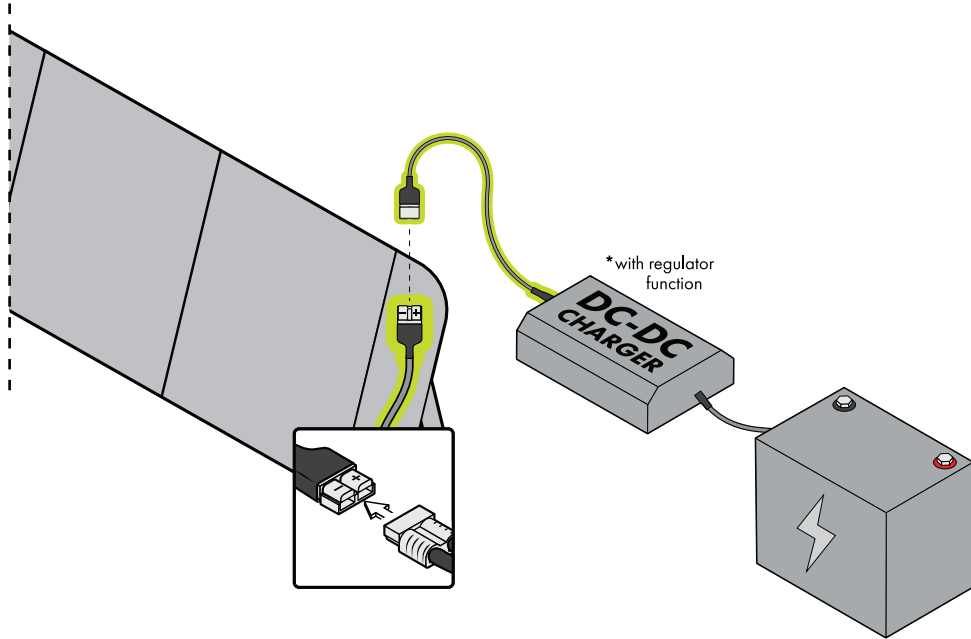

IF USING AN ALTERNATE SOLAR REGULATOR SOURCE SUCH AS A DC-DC, DO NOT PLUG IN ANOTHER REGULATOR

FOLDING GUIDE

Ensure mat is in an upright position. To pack away, simply follow steps in reverse.

1

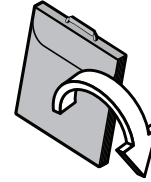

5

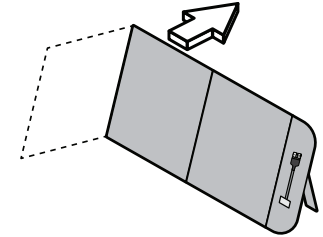

2

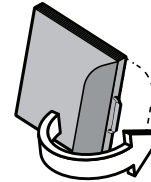

6

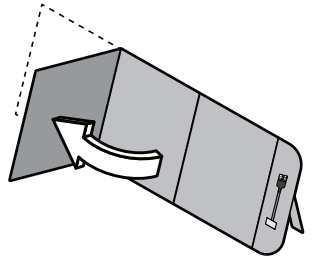

3

⚠
ENSURE PANEL IS SUPPORTED BY IN-BUILT LEGS

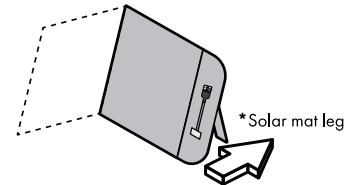

7

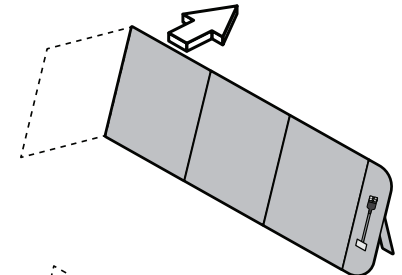

4

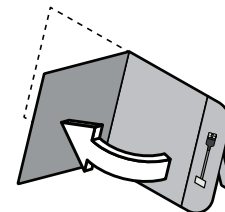

8

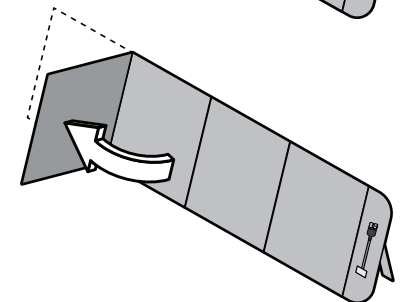

REGULATOR SET-UP

Please check your battery manufacturer's specifications to select correct battery type. The unit has charge programs for six different battery types: Lithium Iron Phosphate (LiFePO₄), Lithium Titanate Oxide (Li₄Ti₅O₁₂), Gel, AGM, Wet and Calcium.

SCREEN NAVIGATION

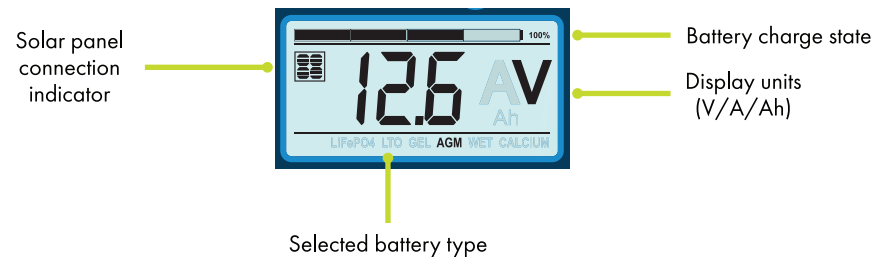

When the unit powers on it will run a self-test sequence as follows:

8.8.8	8.0.8	12.0 15.0A
Self-test starts, digital meter segments test	Software version test	Rated voltage and current test

SETTINGS

After completing the self-test the regulator will commence charging.

Press and hold the **(TYPE)** button for 3 seconds to enter battery selection mode. The regulator will memorise the selected battery for future use.

CAUTION: selecting the wrong battery type may cause damage to your battery.

Press the **(AMP/VOLT)** button to cycle through battery voltage (V), charging current (A) and charged capacity (Ah). Note: at night only voltage will be displayed.

When the battery is fully charged it will alternate between displaying **FULL** and the charge status every 2 seconds.

BATTERY TYPE SELECTION

Ensure the regulator is set up for the correct battery type. Failure to do so may harm the battery.

SPECIFICATIONS	AGM	Wet	Gel	Calcium	LiFePO ₄	LTO
SOFT START	3-10V ± 0.2V - max 7.5					
BULK	10-14V ± 0.2V					
ABSORPTION	14.4V ± 0.2V	14.7V ± 0.2V	14.1V ± 0.2V	14.9V ± 0.2V	14.4V ± 0.2V	14.0V ± 0.2V
EQUALISATION @25°C	N/A	15.5V ± 0.2V	N/A	15.5V ± 0.2V	N/A	N/A
FLOAT	13.6V ± 0.2V				13.4V ± 0.2V	
RESTART	12.8V ± 0.2V				13.3V ± 0.2V	

Note: Absorption will transition to Equalisation when the charging current **drops to 0.5A ± 0.1A** or the charging time reaches 4 hours.

Equalisation charge will be activated when battery voltage is **less than 10V ± 0.2V** or the time since last charge is 28 days. Equalisation charge will timeout after 2 hours.

LED INDICATIONS - CHARGE MODES

LED INDICATIONS						
SOFT START CHARGING	ON	Flash	ON	OFF	OFF	OFF
BULK CHARGING (BATT VOLTAGE < 11.5V ± 0.2V)	ON	ON	ON	OFF	OFF	OFF
BULK CHARGING (BATT. VOLTAGE 11.5V-12.5V ± 0.2V)	ON	ON	OFF	ON	OFF	OFF
BULK CHARGING (BATT. VOLTAGE > 12.5V ± 0.2V)	ON	ON	OFF	OFF	ON	OFF
ABSORPTION CHARGING	ON	ON	OFF	OFF	ON	OFF
EQUALISATION CHARGING	ON	ON	OFF	OFF	ON	OFF
FLOAT CHARGING	ON	OFF	OFF	OFF	ON	ON
AT NIGHT, NO CHARGE	OFF	OFF	Subject to battery voltage			OFF

CHARGE PROGRAMS

This smart regulator has a 6-stage charging algorithm designed charge your battery in a way that suits the status and chemistry of the unit. The regulator automatically cycles through each charge setting, and is able to detect the correct stage to use, no matter what condition your battery is in.

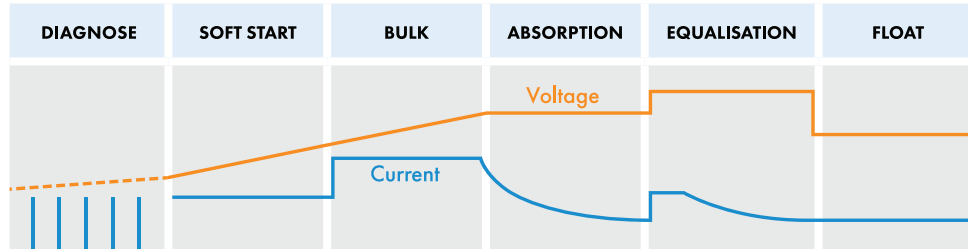

ABOUT EACH CHARGE SETTING

DIAGNOSE (LITHIUM ONLY)	The regulator checks the lithium battery initial voltage to determine whether it should go to Soft start or Bulk charge; if the battery is protected by BMS, the regulator will automatically send a signal periodically to the battery terminals to activate the BMS against protection.
SOFT START	When batteries suffer an over-discharge, the regulator will softly ramp the battery voltage up to 10V.
BULK CHARGE	The regulator will charge the batteries at maximum current until they reach Absorption level (85% of total capacity)
ABSORPTION	Once the battery reaches 85% of total capacity, the regulator will apply a constant voltage charge. Current will taper off as internal resistance rises. LiFePO ₄ , LTO, Gel and AGM batteries will go straight to float charge after absorption stage i.e. an equalisation charge will not be applied.
EQUALISATION (WET,CALCIUM ONLY)	When the battery is deeply drained below 10V or once every 28 days, the regulator will run this stage to bring the internal cells to a state of equal voltage. LiFePO ₄ , LTO, Gel and AGM batteries do not run this stage.
FLOAT CHARGE	The regulator will apply a float charge to maintain a fully charged battery at full capacity.

Note: Batteries will return to bulk charge stage if the regulator detects that their voltage has dropped below the "Restart voltage" stipulated in the specifications table.

FAULT INDICATORS

If the regulator detects an issue in your setup, it will use a range of settings or displays to prompt you.

SOLAR MAT FAULTS	LCD DISPLAY	LED INDICATION	LCD BACKLIGHT
SOLAR PANEL WEAK	Normal	Flash	ON
SOLAR PANEL REVERSE CONNECTION	P01	Flash	Flash
SOLAR PANEL OVER VOLTAGE (> 26.5V)	P02	Flash	Flash

BATTERY FAULTS	LCD DISPLAY	LED INDICATION	LCD BACKLIGHT
BATTERY DISCONNECTED (OR < 3.0V)	B01	ON Flash	Flash
BATTERY REVERSE CONNECTION	B02	Flash	Flash
BATTERY OVER-VOLTAGE (> 16.5V)	B03	Flash	Flash
BATTERY OVER-TEMPERATURE (> 65°C)	B04	Flash	Flash

REGULATOR FAULTS	LCD DISPLAY	LED INDICATION	LCD BACKLIGHT
REGULATOR OVER-TEMPERATURE	OEP	N/A	Flash

SOLAR MAT CARE

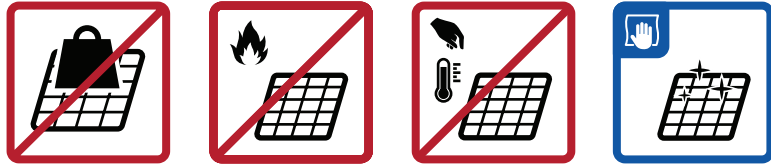

Follow these simple instructions to ensure optimal performance and longevity for your solar mat.

- Do not sit, walk or place any heavy objects on the solar mat.
- Keep solar mat clear of open flames while charging a battery.
- Do not expose solar mat to high temperatures.

CLEANING YOUR SOLAR MAT

Gently clean the surface with a damp cloth to remove any dust or debris that may have accumulated on your solar mat. Avoid any harsh chemicals, as these could damage the material.

FOLDING YOUR SOLAR MAT

When folding the solar mat, it is essential to follow the correct order to prevent creases or tears. Supporting the mat while folding helps prevent strain on the material. See page 3 for folding guide.

POSITIONING YOUR SOLAR MAT

You can place your solar panels anywhere it receives direct sunlight. However, you will experience a moderate increase in output if you are able to angle the panels 30-45° to the sun.

FREQUENTLY ASKED QUESTIONS

Q. Can I connect this solar regulator to an existing battery management system / DC-DC charger with solar input?

A. If you wish to connect your solar panel via an existing battery management system / DC-DC charger, you'll need to bypass included regulator (on HKP200SOL model). Connect your solar panel directly to the solar input port on your battery management system. Always check that the device you wish to use in place of this solar regulator is rated to handle the maximum current capable of being produced by your solar panel.

Q. Why am I getting no power through my solar panel?

A. Check the following:

1. Make sure all Anderson connectors are plugged in at both ends.
2. Make sure a wire has not been pulled out of an Anderson plug.
3. Please ensure the solar regulator is connected directly to a battery (not through any secondary regulator / charger)

(Note: if you need to reset the regulator, you can do so by disconnecting the battery)

Q. Why is my solar panel not producing its rated output?

A. Your solar panel will produce maximum output on a clear (cloudless) day when the UV rating is between 24-28 degrees Celsius. It must also be connected to a battery that is at less than 80% capacity. Once a battery reaches 80% capacity, the regulator will gradually reduce the charge current until it reaches 100%.

HARDKORR



Our goods come with guarantees that cannot be excluded under the Australian Consumer Law. You are entitled to a replacement or refund for a major failure and compensation for any other reasonably foreseeable loss or damage. You are also entitled to have the goods repaired or replaced if the goods fail to be of acceptable quality and the failure does not amount to a major failure.

Hardkorr warrants that this product will be free from defects in material and workmanship for two years. The warranty commences on the date of purchase by the original purchaser, and is not transferable. To access the benefits of this warranty, you must retain your proof of purchase and follow any other direction we reasonably give you (e.g. completing and returning your warranty card if applicable).

TO BEGIN A WARRANTY CLAIM:

If you believe your Hardkorr product is defective, it must be returned to Hardkorr for inspection by our warranty claims department.

1. You must have a Return Authorisation (RA) number. To get your RA number, please complete the form found on our website and wait for the warranty team to contact you.
2. Once you have an RA number, you must arrange for the product must be shipped at your own expense back to Hardkorr (keep your receipt). The address for shipment will be provided when we issue your RA number.
3. Please be sure that your RA number is clearly marked on the outside of the packaging used for shipping.

Completing the steps as mentioned will ensure a faster process of your claim, so that Hardkorr can get your product back to you as soon as possible.

Once we receive your returned product, our technicians will inspect it. We will then notify you of the outcome of your claim.

If we accept your warranty claim, we will either repair, replace or refund the goods at our discretion. We will also reimburse you for the shipping costs you incurred in sending the goods back to us. Any products that we choose to replace or refund become the property of Hardkorr.

If we do not accept your claim, we will advise you of the reason and hold your product for collection. You will need to arrange and pay for the product to be shipped back to you. If your product is not collected within 30 days of your warranty claim being finalised, we may destroy it.

Your warranty is voided if we (at our sole discretion) determine that there is evidence of one or more of the following:

Negligence: Improper installation, improper or extreme use, use that contravenes this instruction manual, etc.

Abuse: Road hazards, Damage beyond the limits of "normal wear and tear."

Unauthorised Repair: Repair service performed by an unauthorised service centre.

Disassembly: Any attempt to open, tamper with or otherwise compromise the integrity of the product.

Consequential damage: Damage to this product caused by the failure of another component of the vehicle or device in which this product is installed.

Note regarding exterior finishes: Hardkorr uses the highest quality materials available, but depending on location, environment and exposure, the colour of exterior surfaces can fade. We will not approve any warranty claims that relate to fade.

DISCONTINUED ITEMS

Discontinued items that are still under warranty will be reviewed by Hardkorr. If a discontinued item is covered under warranty it may be replaced by an equivalent or superior item. If an equivalent item is not available Hardkorr will determine terms of resolution on a case-by-case basis.

LIFE
WITHOUT
LIMITS

HARDKORR™

   @HARDKORRAU

WWW.HARDKORR.COM