INSTRUCTION MANUAL
AEROSPEED 6



AEROSPEED 6

AEROSPEED SERIES

SIDE





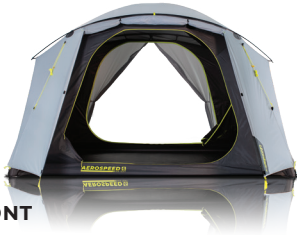







FRONT



REAR



-  External Dimensions
-  Internal Dimensions
-  Removable Curtain
-  Entry/Exit
-  Mesh Vent
-  Mesh Window
-  Door/ Window Cover
-  Internal Floor Area
-  Awning Area
-  Powercord Access
-  Lantern Hanging Point

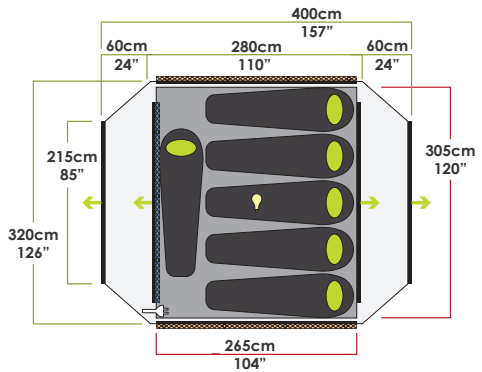



KEY TIPS



Before inflating your tent, start by pegging the corners and ensure the tent is fully pegged with the floor sitting flat. The floor seam should have tension between each peg loop.



Ensure all doors are zipped closed before inflating and deflating. This helps the tent keep its shape and prevents undue stress on panels and zips.



Ensure your air tubes are inflated to the correct pressure by pumping slowly so you can read the pressure on the gauge.



Gently push the brow poles through the sleeve to ensure the segments don't come apart.



Do not over tension guy ropes as your tent is designed to be free standing without the need for these. The guy ropes should be taught but shouldn't pull your tent out of shape.



Ensure to always place the protection cap back on the pump shaft. This will protect your tent fabric from damage when rolling to pack away.



When rolling up door panels, fold the outer corners into the centre and roll inwards. This prevents the edges hanging loose and prevents water from pooling in the roll.



On warm or humid nights, zip down the top of the 360° door cover. This provides maximum ventilation while maintaining your privacy.



SETUP MANUAL

1. UNPACK



2. PREPARE



3. PEG/STAKE



SETUP MANUAL

4. INFLATE

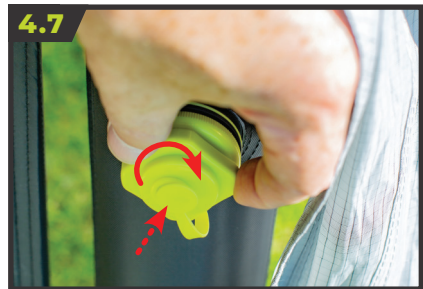
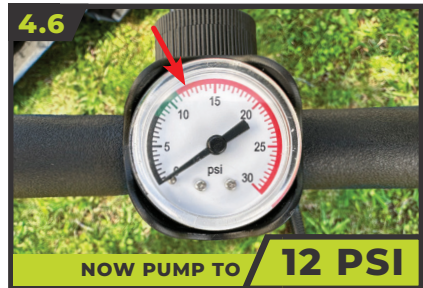
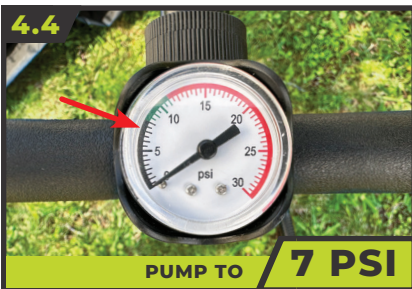
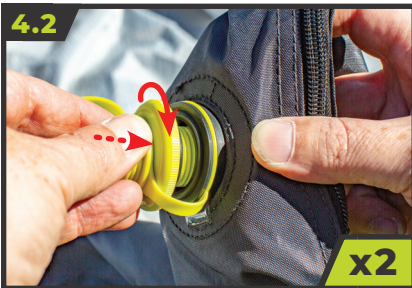

5. BRACE

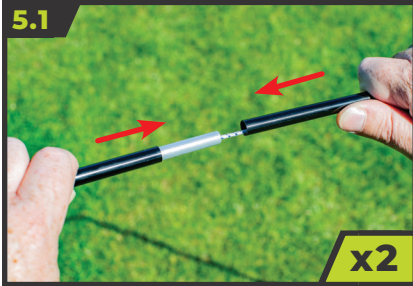

6. TRIM

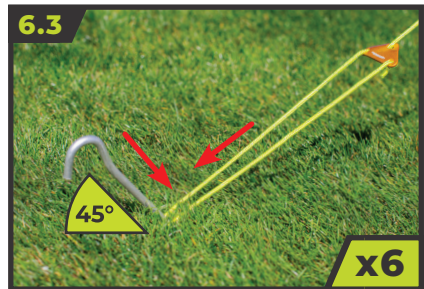

PACKDOWN MANUAL

1. REMOVE POLES



2. CLOSE ZIPS



3. DEFLATE



4. REMOVE PEGS



5. DISASSEMBLE



6. CLEAN & STORE



**GET READY
TO ROLL**



PACKDOWN MANUAL

7. FOLD & ROLL



OPTIONAL ADD-ONS



AEROSPEED 6 WALL SET

2 x zip-on walls add extra protection to the tent's sides, upgrading your Aerospeed to a 4-Season tent.



AEROSPEED 6 AEROBASE LINK

Connects your Aerospeed Air Tent to a Zempire Aerobase Shelter to hugely enhance your campsite, increasing your covered outdoor living space.



AEROSPEED 6 ROOF COVER

Easy to attach to pleasantly decrease the internal temperature and darken the interior, while providing extra protection from UV rays & other debris.



AEROSPEED 6 FOOTPRINT

Fits perfectly under your Aerospeed Air Tent to protect the floor and make pack-away easier.

NEED HELP WITH YOUR TENT?

We have a range of videos on our website which can help you.

Follow the QR code or type the link below in your browser. We suggest to check out our videos beforehand in case you don't have service at your holiday destination.

**TO THE
VIDEO
GALLERY**



ZEMPIRECAMPING.INFO/VIDEO-GALLERY

CARE INSTRUCTIONS

1. Ensure guy ropes are out at all times during use.
2. Make sure you have all vents open at all times. Constant airflow will drastically reduce condensation in humid weather conditions. Never cook in your tent as it is unsafe and would also heavily increase condensation.
3. Ensure all doors are zipped closed before inflating and deflating. This helps keep the tent's shape and prevents stress on panels/zips.
4. Never pack your tent away wet. If you must take your tent down when wet, ensure that it is dried completely as soon as possible to prevent mildew forming.
5. If mildew does form on your tent, wash off with warm water and a soft brush to prevent further growth. Do not use soap or detergents.
6. Do not use aerosol spray cans or an open flame inside your tent. The fabric has been treated with a fire retardant but is in no way fire-proof.
7. Always use a peg puller or another peg to remove pegs. Never remove pegs by pulling the tent or peg loops; always clean and dry pegs before storing.
8. This tent is not designed to withstand storm conditions. During a severe storm, it is recommended that the tent be taken down.
9. Do not leave your tent pitched unnecessarily for extended periods of time. UV light damages the fly and will shorten the life of your tent.

TROUBLESHOOTING

AIR LEAK

- ▶ Check all deflation valves are properly closed.
- ▶ Check seals on inflation valves are intact, clean, and correctly fitted.
- ▶ Check the inflation valve is screwed in and seated correctly into the inflation tube.
- ▶ Check the valve cap cover is firmly tightened.
- ▶ If valve is leaking apply a smear of Vaseline (or similar petroleum jelly) to the O ring seal on the valve.
- ▶ Check for punctures.

WATER LEAK

- ▶ Check for any leaking seams, damaged seam seal tape and moist areas.
- ▶ Check tent for any holes and apply repair tape or seam sealer as required.

RIP IN THE FABRIC

- ▶ Use repair tape as a temporary repair for the tear. If possible, avoid using duct tape.
- ▶ Have repairs carried out by an authorized specialist.

CONDENSATION

During humid or damp conditions, it is recommended that the window covers are opened to expose the mesh layer, enabling additional airflow throughout your tent.

Do not use foam swabs or non-bonded mats directly on the tent floor. This will cause condensation between the mat and floor and if not dried out, can lead to mildew forming.

UV DEGRADATION

Tent fabrics can be weakened by prolonged exposure to sunlight. Under normal holiday use, your Zempire® tent will give you many years of camping enjoyment. However, extended use in strong sunlight will cause degradation. It is recommended that during periods of strong sunlight a Zempire® Roof Cover is used to help protect from UV damage. UV degradation is not covered under warranty. The warranty does not cover permanent sites, displays or commercial use.



2 Year Limited Warranty

Please take time to read about the protection we offer you.

All our products come with a guarantee designed to protect you as our valued customer. Zempire® Camping Equipment will repair or replace this product, at their discretion, should it fail due to faulty materials or manufacture for a period of 2 years from the date of purchase.

The Guarantee is subject to the following conditions:

1. The Guarantee only applies to an original purchaser who purchased this product in an unopened condition from an approved retail outlet.
2. The Guarantee does not apply if the product has been used for anything other than reasonable personal use. Commercial use (e.g. rental) or continuous use are expressly excluded.
3. Damage due to normal wear and tear, accident, acts of God, negligence (other than by Zempire® Camping Equipment), failure by the purchaser to ensure instructions for setting up and care are observed, deterioration due to abnormal exposure to ultraviolet light, damage from wind, insects, animals or mold/mildew, or any other cause reasonably beyond the control of Zempire® Camping Equipment are not covered.
4. If redress is sought under the terms of this Guarantee, then the product must be returned by the purchaser to the outlet from where it was purchased within the Guarantee period, in a clean, dry state and with proof of purchase.
5. All transport costs and any other indirect costs are excluded from the Guarantee.
6. Zempire® Camping Equipment reserves the right to make a reasonable charge for repairs which it determines are not within the scope of the Guarantee.
7. The Guarantee does not limit, modify or exclude any rights under any law if doing so would contravene that law or make any part of this Guarantee invalid. However, Zempire® Camping Equipment:
 - a) excludes (to the extent permitted by applicable law) all conditions and warranties that might otherwise be implied; and
 - b) limits its liability for breach of any such condition or Guarantee that it cannot exclude together with its liability under the Guarantee, to repairing or replacing the Goods or paying the cost of having the Goods repaired or replaced (at Zempire® Camping Equipment's option).

Australia Only

Our goods come with guarantees that cannot be excluded under Australian Consumer Law. You are entitled to a replacement or refund for a major failure and compensation for any other reasonably foreseeable loss or damage. You are also entitled to have the goods repaired or replaced if the goods fail to be of acceptable quality and the failure does not amount to a major failure.

USA Only

Some states do not allow the exclusion or limitation of incidental or consequential damages, so the above limitation or exclusion may not apply to you. This warranty gives you specific legal rights, and you may also have other rights which vary from state to state.

Europe Only

The consumer has legal rights under applicable national legislation governing the sale of consumer goods and those rights are not affected by the guarantee.

All warranty claim processes are explained on our Zempire® website [/warranty](#) and follow the instructions to lodge a warranty claim.

Sales Offices:

New Zealand & Australia

Zempire® Camping Equipment
6 Karewa Place, Pukete,
Hamilton, 3200, New Zealand
Ph: +64 7 848 1610

USA & Canada

Zempire® USA INC.
22525 SE 64th Place, Suite 200
Issaquah, WA, 98027
Ph: +1 206 420 0391

Made with care in China.

Designed and tested in New Zealand.

INFO

Please read this instruction manual carefully and follow all instructions, guidelines, and safety warnings.

Included in this product instruction manual are warnings and precautions in relation to the safe use, care, assembly, maintenance, and storage of this product. By using the product, you confirm that you have read the product instruction manual and understand all warnings and precautions and agree that the product shall only be used for the intended purpose and application in accordance with the instructions, guidelines, and warnings in this product instruction manual as well as in accordance with all applicable laws and regulations. A failure to read, understand and follow the instructions and warnings may result in death or injury to yourself and others as well as damage to your product.

This manual, including the instructions, guidelines, and warnings, and related documentation, may be subject to changes and updates.

These instructions MUST be kept with this product for future reference.

WARNING & SAFETY REFERENCE EXPLANATIONS

 **DANGER!** – Safety instruction: Indicates a hazardous situation that, if not avoided, will result in death or serious injury.

 **WARNING!** – Safety instruction: Indicates a hazardous situation that, if not avoided, could result in death or serious injury.

 **CAUTION!** – Safety instruction: Indicates a hazardous situation that, if not avoided, could result in minor or moderate injury.

 **NOTICE!** – Indicates a situation that, if not avoided, can result in property damage.

 **NOTE!** – Supplementary information for using the product.

DANGER

Failure to obey this instruction will cause death or serious injury.
HAZARD OF CARBON MONOXIDE POISONING



Never use fuel-burning appliances such as barbecues, gas heaters or gas cookers inside the tent. The burning process produces carbon monoxide which accumulates inside the tent and can cause death.

WARNING

Failure to obey these warnings could result in death or serious injury.
FIRE HAZARD

Do not cook inside the tent or use open flames.

WARNING

Failure to obey these warnings could result in death or serious injury.
BEWARE OF SUFFOCATION

Make sure ventilation openings are always open to avoid suffocation.

CAUTION

Failure to obey these cautions could result in minor or moderate injury.
INJURY RISK

This product is not intended for use by persons (including children) with reduced physical, sensory, or mental capabilities, or lack of experience and suitable knowledge, unless they have been given supervision or instruction by a person responsible for their safety.

Guy lines are a trip hazard do not allow children to play near the tent and ensure that suitable protective footwear is worn. Maintenance or cleaning of this tent is not to be undertaken by unsupervised children.

DANGER

Failure to obey this instruction will cause death or serious injury. **ELECTRIC SHOCK AND/OR ELECTROCUTION HAZARD**

· The use of the Power cord access points to run an extension cord into the tent may lead to electric shock, electrocution, fire or explosion hazards.

· **DO NOT** use any extension cord that is worn or damaged in anyway.

· **DO NOT** allow electrical devices, appliances, or extension cord to encounter condensation, water, or moisture inside the tent.

· Only use extension cords that are marked and certified for **OUTDOOR USE**.

· **USA:** Only connect extension cord to a 120 Volt GFCI (ground fault circuit interrupter) protected outlet with proper ground. If GFCI outlet is not available, use an extension cord with GFCI built in protection.

· **AU/NZ:** Only connect extension cord to a 240 Volt RCD (residual current device) protected outlet with proper ground. If RCD outlet is not available, use an extension cord with RCD built in protection.

· Ensure that the extension cord outside the tent is lower than the Power Cord entry into the tent so moisture will not travel along the cord and into the tent.

· Follow all instructions, warnings, and safety precautions from the manufacturer of the extension cord.

· Store tent and extension cord separately.

CAUTION

RISK OF INJURY AND MATERIAL DAMAGE

· Never open the zip on the protective sleeve around an air pole while the pole is inflated. This will result in the air pole bursting.

· Only inflate the air poles to the recommended pressure using the supplied (or Zempire recommended) pump (14 psi/0.96 bar).

INTENDED USE

This tent is suitable for:
Light to moderate weather.

This tent is NOT suitable for: Use above the snowline or in severe winds, commercial use, or long-term pitching.

This product is suitable only for the intended purpose and application in accordance with these instructions. This manual provides information that is necessary for proper and correct use of the product.

Improper use or maintenance will result in diminished performance and potential failure.

The manufacturer accepts no liability for any injury or damage to the product resulting from:

- Incorrect assembly or usage.
- Incorrect maintenance or use of spare parts other than original spare parts recommended and supplied the manufacturer.
- Alteration to the product without express permission from the manufacturer.
- Use for purposes other than those described in this manual.

Zempire® reserves the right to change product appearance and product specifications.

NOTICE

MATERIAL DAMAGE

- During setup **DO NOT** open or close the zippers by force.
- During packdown **DO NOT** use force when dismantling the tent. Otherwise, you might damage fabric and other components.

CLEANING & MAINTENANCE: FABRIC DAMAGE

- **DO NOT** use sharp or hard objects or cleaning agents for cleaning.
- **DO NOT** use mineral-based, soaps, chemicals, or detergents for cleaning.
- Gently remove tree sap and bird droppings from the fabric as soon as possible to avoid permanent damage to the material.
- If necessary, clean the fabric with clean water and a soft bristled brush.

STORAGE

Fully set up the tent for cleaning. Choose a sunny day for cleaning to ensure the material will dry thoroughly.

Clean the tent thoroughly, including the inside to be sure no food etc is left inside to attract rodents etc.

Air the tent fully and ensure the tent is totally dry before packing away.

Store in a well-ventilated dry place inside the supplied carry bag.

DISPOSAL



Recycle all packaging material.

Do not discard into normal household garbage or landfill. Please contact local recycling facilities to recycle.



AS PART OF OUR **ZEMPIRE FAMILY**, SHARE
YOUR **CAMPING MOMENTS** ON SOCIAL



@zempirecamping #zempirefamily

ZEMPIRECAMPING.COM