

4x4

4x4 ACCESSORIES



**120W FOLDING
SOLAR BLANKET**

+ OWNERS/INSTRUCTION MANUAL



Please ensure that you have read the product manual and instruction in full prior to use. Failure to do so may result in incorrect operation and therefore impact on the products performance.

It is recommended this solar system is installed by an experienced professional.

SAFETY/WARNING

- Before using the XTM solar blanket ensure the instructions have been read and understood.
- The solar blanket is not intended for use by young children or infirm persons. Please keep away from pets.
- XTM solar blanket is designed to charge most 12 volt battery types including: Flooded(Lead acid), Gel, Sealed/Mat(AGM), VRLA and LiFePO4 (Lithium) batteries.
- Always wear the appropriate Personal Protective Equipment (PPE) when working near batteries. This includes gloves and eye protection.
- Ensure battery is being charged in a well-ventilated area. Explosive gases may escape from the battery during charging. Never charge a battery in a closed off space or in an area without ventilation.
- Never smoke, use an open flame or create sparks near a battery or charger whilst charging as gases may cause explosion. Please keep burning cigarettes, flames or other ignition sources away from the charging battery at all times.
- XTM Solar blanket is not water resistant or waterproof. Do not expose the solar blanket to water or liquids.
- Do NOT attempt to use the solar blanket if the cables or plugs are damaged. These units do not contain serviceable parts. To avoid a hazard ensure that any damage to the unit, cable or plugs are replaced by a qualified technician.
- Do NOT disassemble the solar blanket. The warranty will be void if this instruction is ignored.
- If battery is still connected in the vehicle, ensure vehicle ignition is switched off before charging the battery.
- Do NOT place the solar blanket on fabric/leather/vinyl seats on the battery or balanced in the engine bay.
- Never charge a frozen battery, non-rechargeable or dry cell battery.
- Do NOT bend or scratch solar blanket.
- Do NOT walk, sit or place heavy items onto the solar blankets or the kit in the bag.
- Do NOT use a high pressure hose to clean the solar blanket. Use a clean microfibre cloth to clean solar blanket surfaces.

XTM 10A MPPT SOLAR CHARGE CONTROLLER

- **DO NOT** disassemble or attempt to repair the controller.
- Power connections must remain tight to avoid excessive heating from a loose connection.
- Only charge 12V batteries that comply with the parameters of the controller.
- Battery connection may be wired to one battery or a bank of batteries.
- Keep in a dry well-ventilated area.
- Use appropriate size cable for the distance required, if unsure consult a qualified professional.

CONNECTION ORDER

STEP 1. Battery Connection

1. Remove fuse from holder in battery cables.
2. Make connections to battery and controller 50A connector wired to battery symbol marked step 1 on the controller. Paying particular attention to “+” and “-“. Red to positive and black to negative on battery.
3. Install the fuses and check for both the PV and Battery LED to be illuminated on the controller after 1 second, both will stay illuminated for 1 second. The PV LED will extinguish. The battery LED may flash depending on the battery voltage.

3a.If hard wiring, connect a fuse in the battery positive circuit, within 150mm of the battery. The fuse must be 1.25 to 2 times the rated current of the controller.



WARNING: If condition 3 is not met stop immediately! Check connections at battery for reverse polarity and correct if necessary. If connections are continued with no LEDs illuminated, irreparable damage will occur. This may even result in FIRE.

STEP 2. Load Connection

1. It is recommended for heavy loads (greater than the claim on the controller) to be connected directly to the battery. All connections to be battery should be adequately fused.
- 2.Remove the fuse from the circuit and make connections to the wires connected to the controller marked step 2. Paying particular attention to the polarity. When finished insert the fuse.
3. If there is no output, check the load does not exceed the current marked on the controller. If required reduce the load and continue.

STEP 3. PV Connection

1.Remove the fuse and connect the solar device (solar panel/blanket) to the 50A connector wired to the controller and marked step 3 . Again, paying particular attention to the polarity then reinsert the fuse.

2.Observe the LEDS and if all connections are correct, after 1 second both the battery and PV LEDS will illuminate for 10 seconds. If all connections are correct the PV LED will start flashing, and the battery LED will be either solid ,or flashing, depending on the battery voltage. Refer to LED indicators section for more information.

FIRST AID & BATTERIES

- For advice, contact the Poisons Information Centre in Australia (PH:13 1126)
- If battery acid makes contact with the skin or clothing, wash immediately with soap and water.
- If battery acid makes contact with the eyes, hold eyelids apart and flush the eye continuously with fresh running water for at least 15 minutes or until the Poisons information centre advises you to stop.
- If battery acid is swallowed, do not induce vomiting. Drink a glass of water and seek medical assistance.

SPECIFICATION:

SOLAR TECHNOLOGY	High Efficiency Monocrystalline
POWER OUTPUT	120 Watt Max @ 20.50V
TESTING CONDITION	AM1.5, 1000W/m ² , 25°C
OPERATING TEMPERATURE FOR PANEL ONLY	-40°C to +85°C
ACCESSORIES	5m extension lead with 50A connectors 90cm extension lead with 50A connector and alligator clips
	10A 12V IP68 Dustproof and waterproof MPPT controller. Suitable for Deep Cycle, GEL, AGM, VRLA, Flooded and LiFePO4 (Lithium) batteries.
DIMENSIONS (mm)	325(L) x425(W) x40(H) (folded) 1510(L) x645(W) x4(H) (open)

CAUTION:

- **ONLY** use and store the product in a dry and well ventilated location.
- **DO NOT** use near flammable liquids or explosives.
- **STOP** use immediately if any wires become loose or electronic components are exposed.

HOW TO USE:

- Unfold the solar blanket.
- Place the solar blanket in a position directly facing the sun. Shadows will reduce optimum power output.
- Tilt the solar blanket at a suitable angle. (Additional support may be necessary)



- Connect the solar blanket to the controller and connect the battery clamp wire to the controller.

1. The below data is the amount of electricity this solar charger can generate under full sun, and ideal working conditions.

QUANTITY	TOTAL SOLAR OUTPUT (WATT)	CHARGING CURRENT (AMP)	CHARGE CONTROLLER INCLUDED
1 Piece	120 Watt	5.86A	10A/12V

2. The solar blanket generates electricity in proportion to the amount of sunlight exposed to the solar panels. The peak generation of power is on a clear day when the sun is at a correct angle toward the solar panels. Cloud cover, seasonal variations, incidental shading and dust and dirt on the solar blanket could decrease the performance of the solar charger.

3. Power loss during transmission through lead wire and connector, efficiency of charge controller and inverter will also decrease the amount of electricity you can generate.

- Do not pick the solar blanket up directly by the solar cells.
- Use the gap between the solar cells to pick the blanket up as illustrated below:

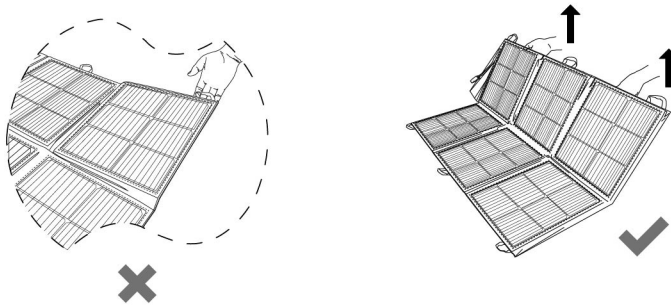

Do NOT stand or walk on the solar blanket.

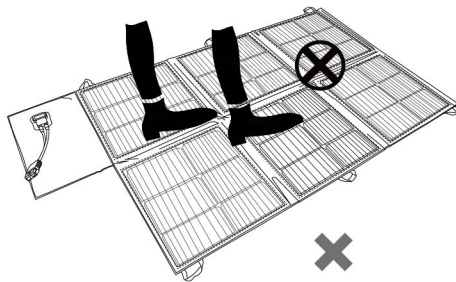

CHARGING A 12V BATTERY

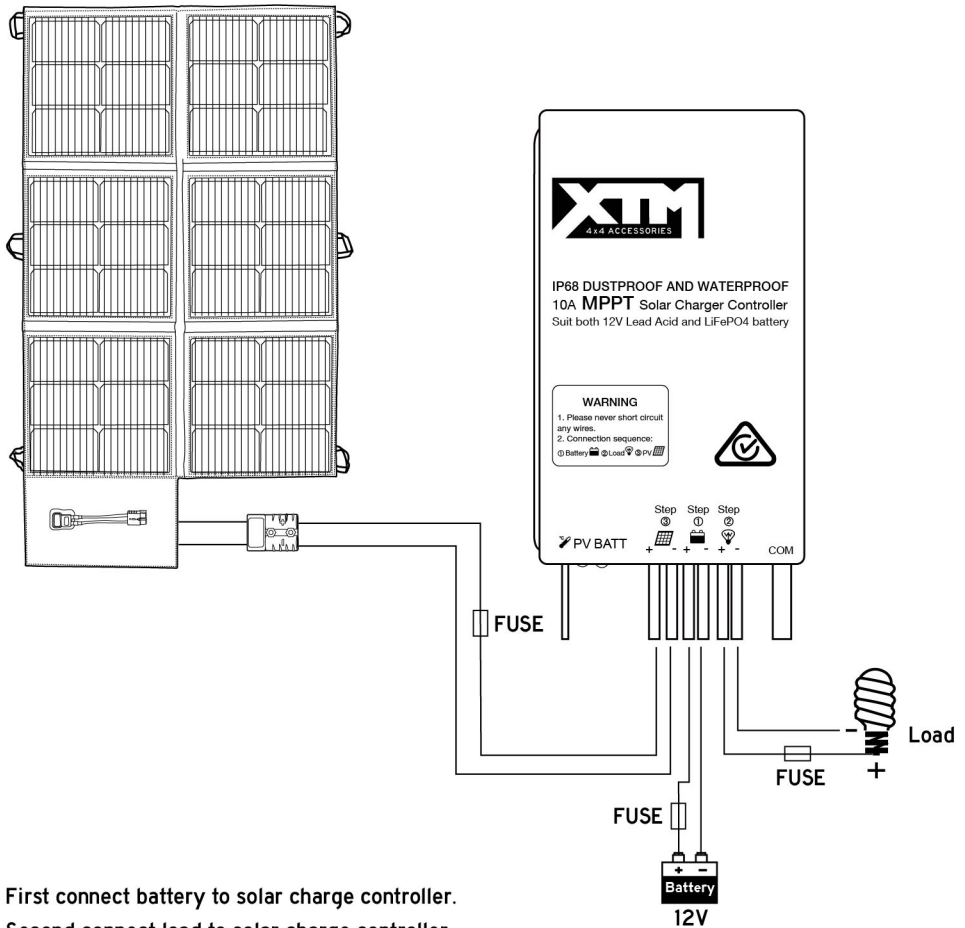

- First connect battery to solar charge controller.
- Second connect load to solar charge controller.
- Finally connect solar blanket to solar charge controller.

NOTE: Heavy loads should be connected to the battery directly.

Do not expose connections to water.

XTM 10A MPPT SOLAR CHARGE CONTROLLER

1. SAFETY INFORMATION

- Read all the instructions in the manual before installation.
- DO NOT disassemble or attempt to repair the controller.
- Install external fuse or breaker as required.
- Do disconnect the solar module and fuse near to battery before installing or moving the controller.
- Power connections must remain tight to avoid excessive heating from a loose connection.
- Only charge batteries that comply with the parameters of controller.
- Battery connection may be wired to one battery or a bank of batteries.
- Risk of electric shock, the PV and load can produce high voltages when the controller is working.

2. PRODUCT FEATURES

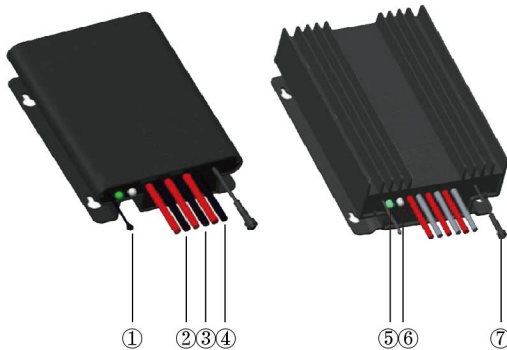



①	Temperature Sensor	⑤	Charging Status LED indicator
②	PV Positive and Negative Wires	⑥	Battery Status LED indicator
③	Battery Positive and Negative Wires	⑦	Waterproof Cap
④	Load Positive and Negative Wires		

- NOTE:** 1. The temperature sensor short-circuited or damage, the controller will be charging or discharging at the default temperature 25°C.
2. The waterproof cap must be fitted to prevent water & dust entering the unit.
3. COM adaptor not available with this unit.

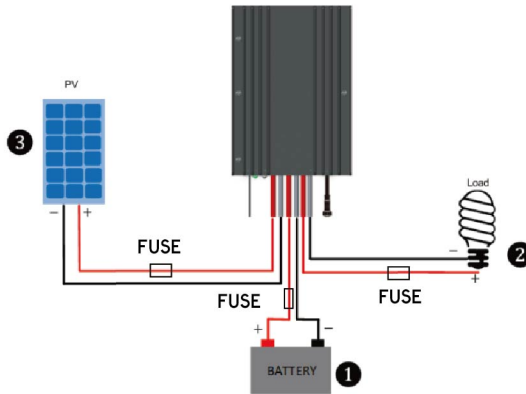
3. WIRING



4. LED INDICATORS

Indicator	Color	Status	Instruction
	Green	On Solid	Photovoltaic (PV) connection normal but low voltage (irradiance) from PV, no charging
	Green	Off	No PV voltage (night time) or PV connection problem
	Green	Slowly Flashing (1 flash per second)	Charging
	Green	Fast Flashing (4 flashes per second)	PV Over voltage
	Green	On Solid	Normal
	Green	Slowly Flashing (1 flash per second)	Full
	Green	Fast Flashing (4 flashes per second)	Over voltage
	Red	On Solid	Over discharged
	Red	Fast Flashing (4 flashes per second)	Battery Overheating
Charging (green) and battery indicator (orange) flashing simultaneously			System voltage error

5. INBUILT CONTROLLER PROTECTIONS

Photovoltaic(PV) Protections:

- **PV Over Current**

Where PV over current occurs, battery charging will be limited to the maximum battery current rating. Oversized solar arrays will therefore not operate at peak power.

- **PV Short Circuit**

Where PV short circuit occurs, or PV input short circuits on lower power, charging will stop, the controller will turn off and the LED not be illuminated. Disconnect PV input from controller and check for short circuit in the wiring and reconnect.



WARNING: Damage to the controller may occur where PV input short circuits on high power.

- **PV Reverse Polarity**

Where reserve polarity occurs, check the wire connections and resume normal operation.



WARNING: If this controller is connected to a different PV to the one supplied and the power from that solar panel (PV) is greater than 195W damage WILL occur to controller.

Battery Protections

- **Battery Reverse Polarity**

Where battery reverse polarity occurs, check wire connections and resume normal operation.

- **Battery Over Voltage (16V)**

Where over voltage is detected, the controller will stop charging the battery, to prevent damage to the battery. Refer to section 7 Technical specifications.

- **Battery Over Discharge (11.1V)**

Where over discharge (low voltage) is detected, the controller will stop power supply to load, to prevent damage to the battery. Refer to section 7 Technical specifications.

- **Battery Overheating**

The controller monitors environmental temperature via a sensor. Where environmental temperatures exceed 65°C, the controller will cease charging until the temperature reached 55°C, after which charging will resume.

- **Temperature Sensor Error**

If temperature sensor faults, the controller will continue to charge/discharge battery at the default temperature of 25°C, to prevent damage to the battery from overcharging & low voltage.

- **Lithium battery Low Temperature**

The temperature sensor is less than the low-temperature value -10°C, and the Lithium battery stops charging/discharging. It is higher than the low-temperature value -10°C, and the Lithium battery starts charging/discharging.

- **Load Overload**

The controller will disconnect the load where the load current exceeds the maximum load current rating of 1.05 times (10.5 amps). Where overload does occur, reduce load demand and restart controller.

- **Load Short Circuit**

The controller will disconnect the load if short circuit (greater than or equal to 40 amps) occurs and will attempt reconnection 5 times. If reconnection attempts fail, the user must clear short circuit by disconnection the controller from the circuit, check all the wiring for the short circuit and reconnect the controller (follow the steps outlined on the front of the controller) to reset. If restart fails, please refer to 6 Troubleshooting.

6. TROUBLESHOOTING

Faults	Possible reasons	
LED charging indicator turns off in daylight, despite PV modules under direct sun.	Photovoltaic(PV) array disconnection	Check PV & battery wire connections are correct and tight.
No LED indicator	Battery voltage may be less than 8.5V	Measure battery voltage with a multi-meter. A minimum of 8.5V are required to power the controller.
Battery LED indicator - fast flashing - green	Battery over voltage	Check if battery voltage is higher than the over voltage disconnect and disconnect the PV.
Battery LED indicator red	Battery over discharged	When the battery voltage is restored to or above LVR point (low voltage reconnect voltage), the load will recover.
Battery LED indicator red flashing	Battery Overheating	The controller will automatically turn off until temperature falls below 55 °C, then resume normal operation.
Load output has stopped	Load Overload ^	① Reduce output load demand. ② Restart controller.
	Load Short Circuit ^	① Check load connections, clear controller fault. ② Restart controller.

^ Where overload or short circuit occurs and the controller ceases charging, it will then attempt auto-recovery 5 times, in the following timing intervals: 5s, 10s, 15s, 20s and 25s.

7. TECHNICAL SPECIFICATIONS

Item	Model	Tracer2606BP
Nominal system voltage		12VDC
Battery input voltage range		8.5~32VDC
Rated charge/discharge current		10A
Rated charge power		130W
Max. PV open circuit voltage		58V(at minimum operating environment temperature) 46V(at 25°C environment temperature)
MPPT Voltage range		(Battery voltage+2V)~36V
Battery Type		Sealed/Gel/Flooded/LiFePO4 (Lithium)
Equalize Charging Voltage		14.4V
Boost Charging Voltage		14.4V
Float Charging Voltage		13.8V
Over Voltage Disconnect Voltage		16V
Low Voltage Reconnect Voltage		12.8V
Low Voltage Disconnect Voltage		11.1V
Self-consumption		≤13mA
Temperature compensation coefficient		-3mv/°C/2V
Working environment temperature		-10°C~+60°C
Enclosure		IP68
Overall dimension		124x89x30mm
Mounting hole size		Φ 3.5mm
Mounting dimension		88x76mm
Net weight		0.54kg

8. DISCLAIMER

Under the following conditions, product warranty does not cover/apply:

- Damage caused through misuse, including use within unsuitable environments.
- Damage caused as a result of PV, load current, voltage or power exceeding the rated value of the controller.
- Damage caused from use in excessively hot environments.
- If the controller has been disassembled, opened or altered by the user.
- Damage caused from natural elements, for example lightning.
- Damage caused during transportation by the user.
- **Damage caused by exposing connections to water.**

FREQUENTLY ASKED QUESTIONS

Q. What type of batteries can be used with the solar blanket kit?

A. Deep Cycle, Gel, AGM, VRLA, Flooded and LiFePO4 (Lithium) batteries.

Q. Will the solar blanket over charge my battery?

A. No. The solar blanket solar charge controller ensures that a steady charge is supplied to the battery without over charging.

Q. Can I extend or lengthen the battery lead wire?

A. If the lead is extended, this can result in a loss of voltage causing insufficient power being transferred from the solar blanket. Use appropriate size cable for the distance required, if unsure consult a qualified professional. Product modifications will void your warranty.

Q. How do I clean the solar blanket?

A. Dust & dirt should first be swept off the panel surface using a soft brush or a microfibre cloth. Then, using a clean microfibre cloth, wipe the solar panel surfaces to remove remaining dirt & grime. It is recommended that any bird droppings be removed as soon as possible to avoid surface damage.

Q. Is the solar blanket waterproof or water resistant?

A. No, the solar blanket is not waterproof or water resistant. Do not expose the solar blanket to water or liquids.

Q. Is the 12V 10A MPPT solar charge controller waterproof?

A. Yes, the controller is IP68 rated, waterproof and dust proof.

NOTE: Do not expose connections to water.

Q. What is photovoltaic?

A. The photovoltaic(PV) effect are solar cells that produce direct current electricity from sunlight which can be used to power equipment or to recharge a battery.

WARRANTY

Our product is guaranteed to be free from quality and manufacturing defects for a period of 12 months.

If your product becomes defective during this period, SRGS PTY LTD will offer you either a replacement, credit or refund where a product is faulty; wrongly described; different from the sample shown to you or do not do what they are supposed to do.

This warranty will not cover substantially modified product; misuse or abuse of the product contrary to user instructions or packaging label; change of mind and normal wear and tear.

Our goods come with guarantees that cannot be excluded under the Australian Consumer Law. You are entitled to a replacement or refund for a major failure and for compensation for any other reasonably foreseeable loss or damage. You are also entitled to have the goods repaired or replaced if the goods fail to be of acceptable quality and failure does not amount to a major failure.

To claim the warranty, take the product to the front Service Desk of your nearest store of purchase. You will need to show receipt or other proof of purchase. Additional information may be required to process your claim. Should you not be able to provide proof of purchase with a receipt or bank statement, identification showing name, address and signature may be required to process your claim.

Any expenses relating to the return of your product to the store will normally have to be paid by you. For online store purchases, SRGS PTY LTD will pay for the return freight for any product assessed as having a major failure.

The benefits to the customer given by this warranty are in addition to other rights and remedies of the Australian Consumer Law in relation to the goods or services to which this warranty relates.

This warranty is provided by SRGS PTY LTD, 6 Coulthards Avenue, Strathpine QLD 4500, Australia. Phone: 1300 880 764.



PLU	690247
Construction	Monocrystalline solar panels
Max power (Nom.)	120W
Dimensions (folded)	325x425x40mm
Dimensions (open)	1510x645x4mm
Max power voltage	20.5V
Max power current	5.86A
Open circuit voltage	24.19V
Short circuit current	6.43A
Power Tolerance	±3%
Cable length	5+0.9 Metre
Operating temperature for panel only	-40°C to +85°C
Standard test conditions	AM1.5 1000W/m ² 25°C
Manufactured in	China



PLU: 690247 CODE: 120WBLANKET
Manufactured & packaged for
SRGS PTY LTD
ABN 23 113 230 050
6 Coulthards Avenue Strathpine QLD 4500, Australia
MADE IN CHINA