

HARDKORR™

USER MANUAL

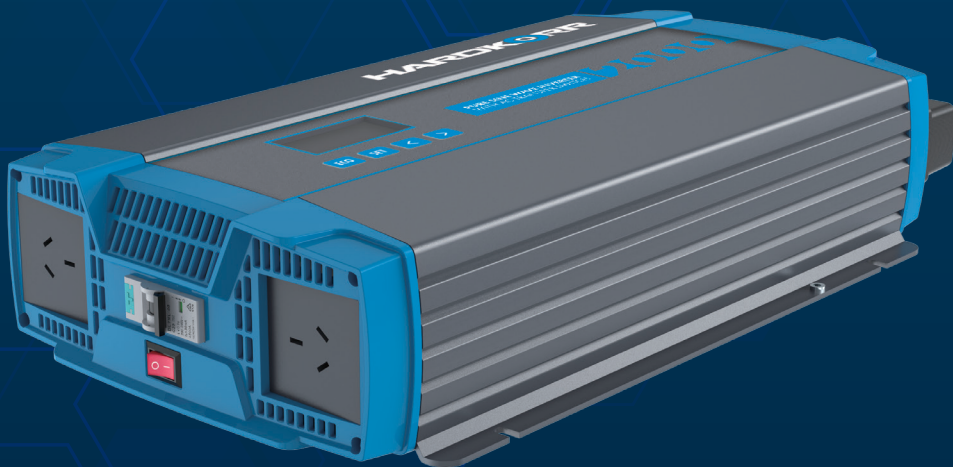

PURE SINE INVERTERS WITH AC TRANSFER SWITCH

HKPINVAC1000 / HKPINVAC2000 / HKPINVAC3000

CONGRATULATIONS ON PURCHASING THIS HIGH QUALITY **HARDKORR PRODUCT!**

In doing so, you now have the assurance and peace of mind that comes from purchasing a product that has been manufactured to the highest quality standards.

Our aim is for you to be completely satisfied with your purchase, and therefore your new Hardkorr product is backed by a comprehensive warranty and an outstanding after-sales customer service team.

We hope you will enjoy using this product for many years to come.

If you require technical support, or in the unlikely event your purchase appears to be faulty, please contact our support team for immediate assistance. Contact details for each country are contained within this user guide.

- THE HARDKORR TEAM

CONTENTS

SAFETY INSTRUCTIONS	1
OVERVIEW	2
SPECIFICATIONS	5
INSTALLATION	7
INSTALLATION - DC	8
INSTALLATION - AC	13
INSTALLATION - REMOTE	15
OPERATION	16
AC OUTPUT	17
ECO MODE	18
SCREEN NAVIGATION	19
FAULT CODES	21
WARRANTY INFORMATION	23

DISCLAIMER

While caution has been taken to ensure the accuracy of the contents of this guide, Hardkorr assumes no responsibility for errors or omissions. Please note that specifications and product functionality may change without notice.

For assistance with assembly or installation, parts and service, please visit www.hardkorr.com or contact customer service through the following:



Toll Free:

1800 533 544

Monday - Friday

9AM - 4PM (AEST)



Language spoken: English

support@hardkorr.com

IMPORTANT, RETAIN FOR FUTURE REFERENCE: READ CAREFULLY

- Before installing or using the product, ensure you have read and understood all of the warning and safety messages supplied with your product.
- Our range of inverters should be installed by licensed professionals only.
- Before installing, cleaning, or inspecting the unit for maintenance, ensure that the inverter is disconnected.
- Children, those without the proper training or experience, or those under the influence of drugs or alcohol should not operate this unit.
- Before wiring up the inverter, make sure to inspect your leads to make sure they are free from faults or frays. The cables used to connect the battery to the inverter need to be of a particular gauge. Consult the wiring guide found in this manual for more information. Failure to use leads fit for purpose may cause fire, shock, or damage to the unit.
- Reverse polarity will cause the inverter's fuses to blow and may damage the inverter. Make sure to pay close attention when hooking up the inverter, ensuring that the negative and positive terminals are clean and are connected to the correct corresponding battery terminals.
- It's common for the inverter to arc when wiring up the final connection. Make sure to keep any flammable materials away from the installation area.
- Do not store or operate the inverter in a location where it may be subject to water, temperatures below -20°C or above 40°C , or in areas where it's at risk of contacting chemicals, fumes, or gases.
- The inverter contains sensitive electrical equipment which may be damaged if the unit is subjected to pressure or impact. Ensure that the inverter is securely mounted to prevent it from falling.
- The inverter should be installed in a way that allows for proper ventilation around the unit. Ensure that the fans and vents are not obstructed. We recommend having at least 100mm of clearance around the unit to allow for adequate airflow.
- The inverter should only be used with appliances that are in safe working condition. Make sure to inspect both the wattage of the appliance and its leads and wires before operating.
- The inverter generates AC 240V power which, in extreme situations, can cause severe injury or death. Whilst the inverter has been engineered with advanced internal protections, caution should be used when operating the unit. Metal objects (except for dedicated plugs) should be kept away from the inverter's ports.
- The inverter should not be opened or disassembled under any circumstance. Doing so will void the warranty and may cause damage/injury to those in proximity.

PURPOSE

Our Pure Sine Wave Inverters are designed to convert your 12V power, from your battery system, into safe and reliable 240V power. This allows you to operate appliances you'd usually run off AC/ mains power from the comfort of your caravan, camper, or touring setup wherever you've decided to set up.

The units are equipped with an AC Transfer Switch feature. Particularly useful when you've set up at a powered site at a caravan park or decided to run the generator, the inverter will seamlessly transition from running via 12V to AC input. The feature assists in conserving your batteries by creating a more efficient transfer of power.

PRODUCT OVERVIEW

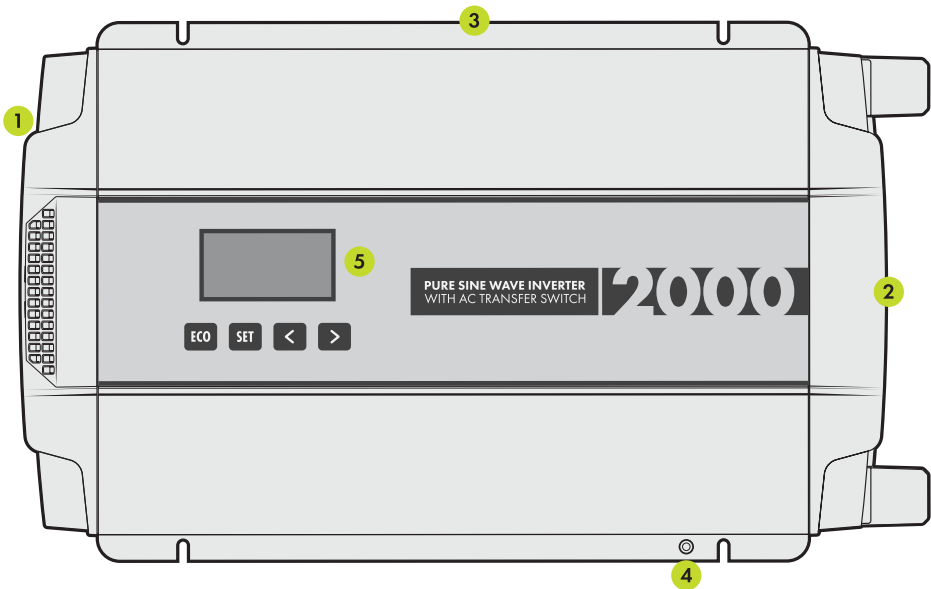

#	ITEM	DESCRIPTION
1	Output side	On/off switch, RCD switch, and 240V output access.
2	Input side	Positive/negative terminals, IEC UPS connection, and inverter remote port.
3	Mounting flange	Used for mounting inverter to surface.
4	Grounding terminal	Screw on port used to earth the inverter.
5	Inverter display	Displays live information of inverter power usage - 2000W & 3000W only.

INPUT

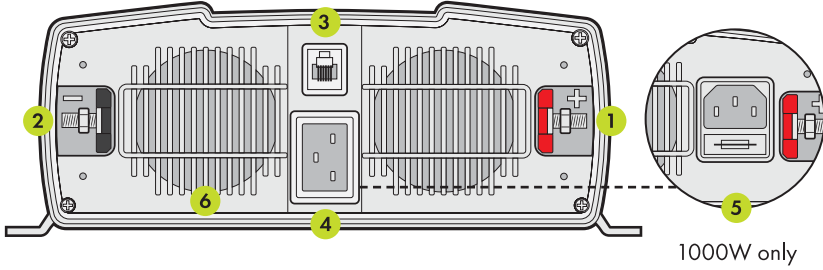

OUTPUT

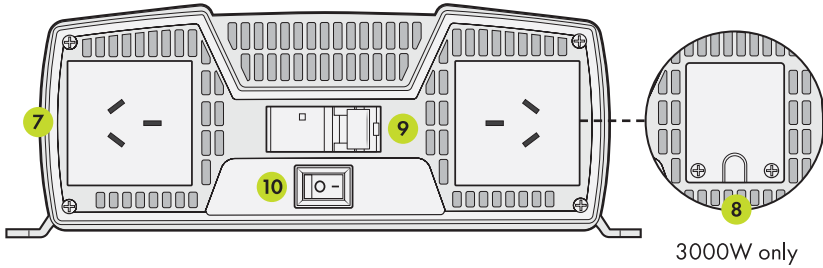

#	ITEM	DESCRIPTION
1	Positive terminal	Direct connection for positive lead from battery.
2	Negative terminal	Direct connection for negative lead from battery or shunt if connected.
3	RJ12 port	Used for connecting the inverter remote control.
4	IEC-C20 socket	Connects inverter to 240V AC power - 2000W & 3000W only.
5	IEC-C14 socket	Connects inverter to 240V AC power - 1000W only.
6	60mm fan exhaust shroud	Removes hot air from inverter case. DO NOT COVER.
7	Type I 240V socket	Used for connecting appliances to the inverter.
8	Hard wire terminal block	Allows hard-wired connection for caravans - 3000W inverter only. Installation is to be performed only by a licensed electrician.
9	RCD protection switch	Shuts electrical supply off when earth leakage is detected.
10	Inverter on/off switch	Turns on/off inverter.

INVERTER REMOTE CONTROL OVERVIEW

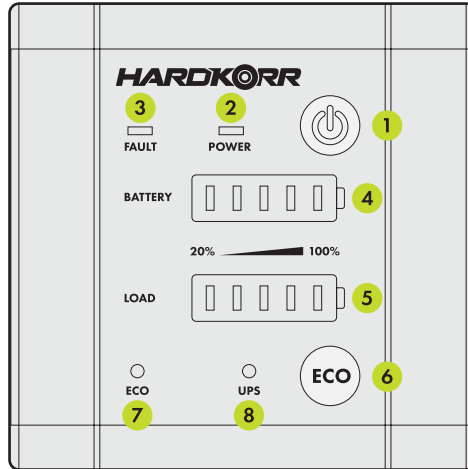

#	ITEM	DESCRIPTION
1	Power button	Press and hold for three seconds to turn the inverter on/off.
2	Power indicator LED	The LED will be lit when the inverter is on and will flash when it's off.
3	Fault indicator LED	The fault indicator will illuminate when the inverter encounters a fault.
4	Battery voltage meter	Based on the DC input's voltage.
5	Load meter	Based on the inverter's load capacity.
6	ECO mode button	Enable/disable the inverter's ECO function - 2000W & 3000W only.
7	ECO mode indicator LED	Illuminated when the ECO mode function is enabled - 2000W & 3000W only.
8	UPS mode indicator LED	Illuminated when the inverter is running via AC input.

OPERATING THE REMOTE

The inverter remote gives you the ability to operate the inverter's basic features in a more convenient location. For the remote to work, the power switch on the inverter must be turned on.

To turn the inverter on/off, press and hold the  button for **4 seconds**. The eco mode function can also be enabled/disabled simply by pressing the "ECO" button (available only on the 2000W and 3000W models).

PRODUCT SPECIFICATIONS

SPECIFICATIONS	HKPINVAC1000	HKPINVAC2000	HKPINVAC3000
BATTERY TYPE COMPATIBILITY	12V SLA, AGM, Gel, Calcium, LiFePO ₄		
INPUT VOLTAGE	10.5 - 15.5V		
OUTPUT POWER	1000W	2000W	3000W
OUTPUT PLUG RATING	10A	10A	15A
SURGE WATTAGE (2 SECONDS)	2000W	4000W	6000W
OUTPUT VOLTAGE & CURRENT	220-240V AC, 50Hz	220-240V AC, 50Hz	220-240V AC, 50Hz
ADJUSTABLE OUTPUT VOLTAGE LEVEL	220, 225, 230, 235, 240V AC		
NO LOAD CURRENT	<1.1A	<1.3A	<1.6A
ECO-MODE CURRENT	N/A	<0.2A	<0.2A
EFFICIENCY	Full load >89%, Half load >92%		
OUTPUT WAVEFORM	Pure sine-wave		
TOTAL HARMONIC DISTORTION	<3%		
IP RATING	IP22		
OPERATING TEMPERATURE	-20°C – 40°C		
STORAGE TEMPERATURE	-30°C – 70°C		
STORAGE HUMIDITY	10–95% Relative Humidity (RH)		
DIMENSIONS (MM)	404 (L) x 209 (W) x 78.7 (H)	452.7 (L) x 253 (W) x 94 (H)	505.5 (L) x 278.4 (W) x 103 (H)
WEIGHT	3.1kg	5.1kg	6.7kg

SPECIFICATIONS

HKPINVAC1000

HKPINVAC2000

HKPINVAC3000

PROTECTIONS	Over/under-voltage protection, short circuit/overload protection, over-temperature protection
OVER-VOLTAGE PROTECTION	15.5±0.2V DC
UNDER-VOLTAGE PROTECTION	10.5±0.2V DC
SHORT-CIRCUIT PROTECTION	1 second shutdown

AC TRANSFER SWITCH FUNCTION

HKPINVAC1000

HKPINVAC2000

HKPINVAC3000

OUTPUT POWER	2400W	3600W
ACCEPTABLE VOLTAGE	220-240V AC	
AC TRANSFER SWITCH TIME	<30ms	

REMOTE CONTROL

REMOTE INPUT	REMOTE-RS
TERMINAL	RJ11
DIMENSIONS (MM)	85 (L) x 86 (W) x 19 (D)

CERTIFICATIONS

- AS/NZS 4763:2011
- IEC/EN 62368-1
- Relay - IEC 61810-1

MOUNTING REQUIREMENTS

The inverter should be mounted in a that fits the following criteria:

- **STABLE** - The inverter must be mounted on a surface capable of holding its weight, using all four mounting points with the appropriate fasteners.
- **ORIENTATION** - The inverter should ideally be mounted horizontally either on a wall or flat surface with the base facing downward. You can mount the inverter vertically on a wall, however this orientation is less ideal due to the possibility of stress on the circuit board. **Do not mount the inverter base up on any surface, as this puts higher stress on the circuit board and risks damaging components.**

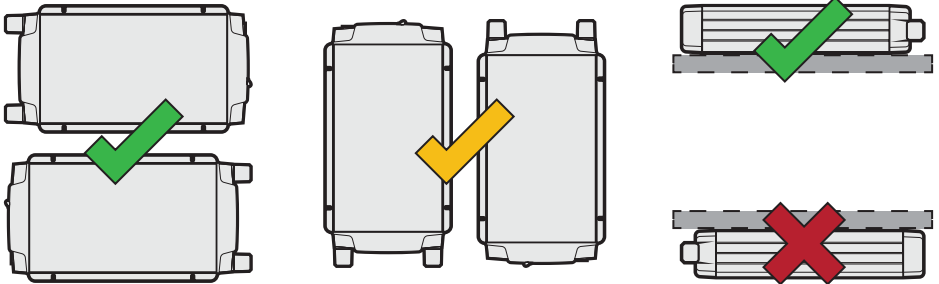

- **DRY** - The inverter must be mounted in an area free from water ingress of any kind.
- **COOL** - For optimal operating conditions, choose a location that stays within the temperature range of between **0°C** and **40°C**.
- **SAFE** - The inverter must be mounted in an area free from fumes and other hazardous substances.
- **VENTILATED** - Ensure a margin of at least **100mm** around the inverter to reduce heat build-up.
- **LIMITED DUST** - The inverter must be mounted in an area with little to no dust ingress to reduce the likelihood of dust being drawn in by the fans when in operation.
- **ELECTRICALLY SAFE** - Ensure the inverter is mounted close to the battery to reduce any significant drop in voltage. With this in mind, the inverter must not be mounted within 300mm of the battery. A fuse must be fitted between the inverter and battery on the positive cable, with the fuse fitted close to the battery end to protect the cable.

BATTERY PREPARATION

Before installing your inverter, consult your battery’s user guide to make sure they are:

- Operating as a dedicated 12V battery.
- Of either an SLA, AGM, Gel, Calcium, or LiFePO4 chemistry.
- In good working order, free from any fault or damage.

Additionally, the batteries should be equipped with a high enough continuous discharge rate to cater to the highest draw of the inverter. The guide below details the maximum current draw for each inverter.

	HKPINVAC1000	HKPINVAC2000	HKPINVAC3000
MAX CURRENT DRAW	94A	187A	281A

The inverters are also able to be powered by systems running with batteries connected in parallel. For some batteries, the maximum continuous discharge rate will be increased when paralleled with a compatible unit. Before wiring the inverter to a parallel setup, consult your battery’s user manual to ensure that it matches the above criteria. Below is a guide outlining how the inverter should be wired to a parallel system.

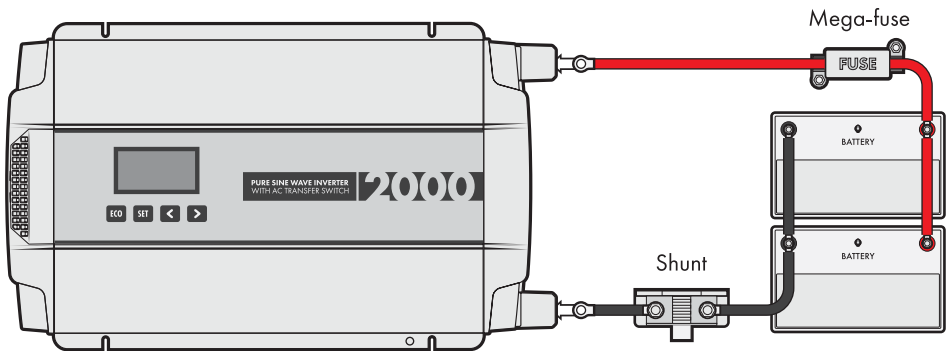

CABLE & FUSE GUIDE

FUSES MUST BE FITTED CLOSEST TO BATTERY POSITIVE TERMINAL

The cable between the inverter and battery must be of a large enough gauge to prevent significant voltage drop over the length of the cable. Because voltage drop occurs between the battery positive and ground, the total cable length combined (positive and negative) needs to be considered.

NOTE: The cables should be routed in a way that prevents them from being damaged. Consider cable conduit or protective tubing to reduce abrasion.

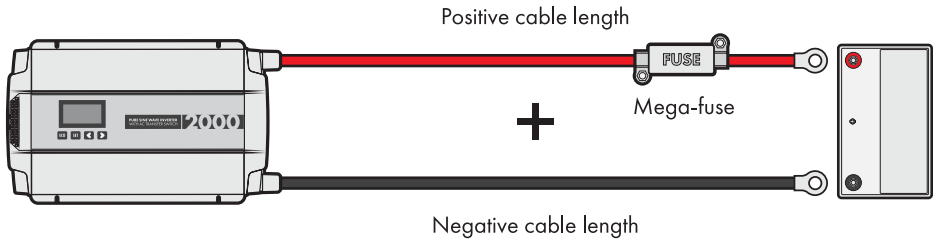

TOTAL CABLE LENGTH = POSITIVE CABLE LENGTH + NEGATIVE CABLE LENGTH

CABLE LENGTH (COMBINED)	CABLE GAUGE mm ² (AWG)		
	HKPINVAC1000	HKPINVAC2000	HKPINVAC3000
0 - 1M	35mm ² (2)	70mm ² (2/0)	95mm ² (3/0)
1 - 2M	35mm ² (2)	70mm ² (2/0)	95mm ² (3/0)
2 - 3M	50mm ² (1/0)	95mm ² (3/0)	120mm ² (4/0)
3 - 4M	70mm ² (2/0)	120mm ² (4/0)	Not recommended
4 - 5M	95mm ² (3/0)	Not recommended	
OVER 5M	Not recommended		

FUSE SIZE	HKPINVAC1000	HKPINVAC2000	HKPINVAC3000
MEGA FUSE	150A	250A	350A

INSTALLATION



INSTALLATION OF THIS DEVICE MUST BE PERFORMED BY A LICENCED PROFESSIONAL

Before wiring the inverter into your system, ensure the inverter switch is on the OFF position and nothing is plugged into the AC outputs.

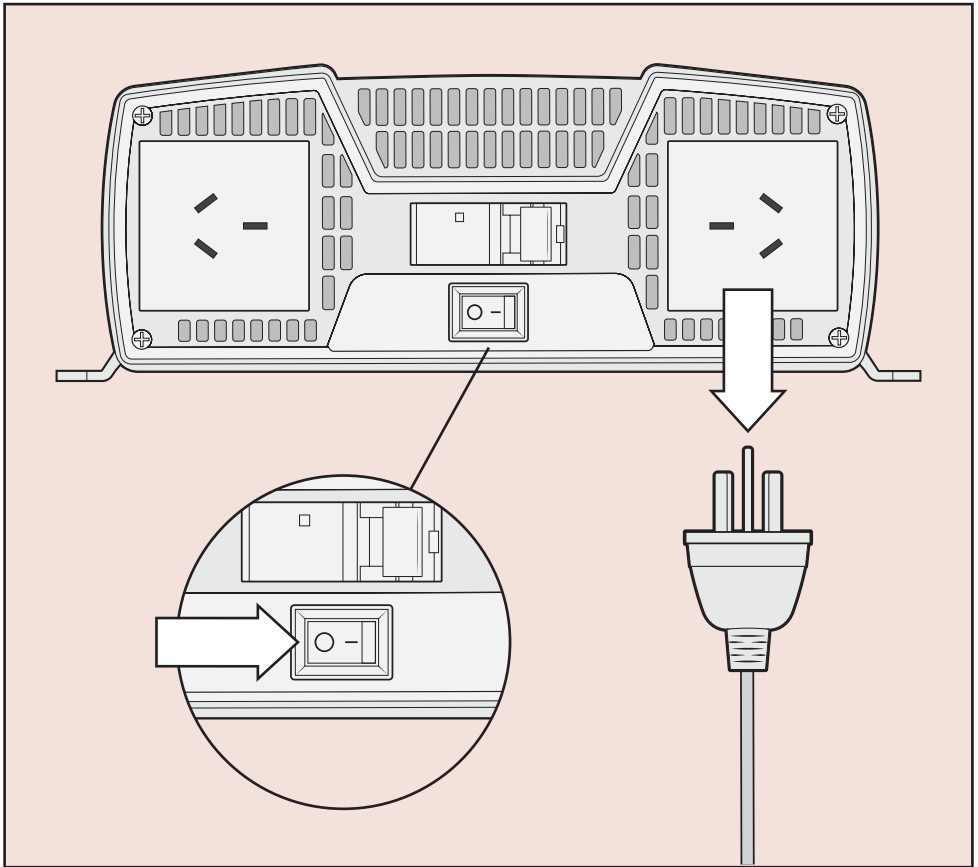

THIS PROCESS MUST BE COMPLETED BEFORE ANY INSTALLATION

CHASSIS GROUNDING

The inverter must be grounded properly before operating. Failure to do so will increase the risk of damage or injury.

The Inverter's dedicated grounding point can be found on the mounting flange of the unit, close to the negative terminal.

Ground the unit using a cable with a minimum of 4mm² copper conductor by screwing the cable into the inverter's grounding point. The other end of the cable should be attached to an appropriate earthing point – this may be the vehicle frame or the battery's negative terminal if it has been grounded.

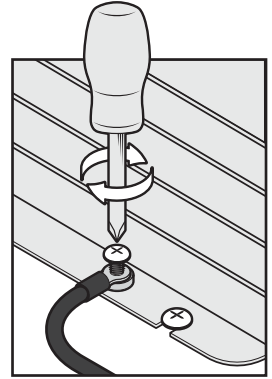

CONNECTING THE BATTERY

1. Before proceeding, ensure that you have the appropriate-sized cables and fuses outlined earlier in this manual. Make sure that you've also read the power isolation requirements found on page 10.
2. Remove the inverter's plastic terminal covers by loosening the screws at the top and bottom of the covers. Thread these covers over the top of the leads you'll be using to connect to the inverter.
3. Next, remove the nuts and washers from the inverter's terminals.
4. The positive and negative cables should then be fastened to their respective input terminals. Connect the positive lead first, by threading the cable eye and washers over the bolt; then fasten it with your nut so it's secure. Repeat this process with the negative lead.

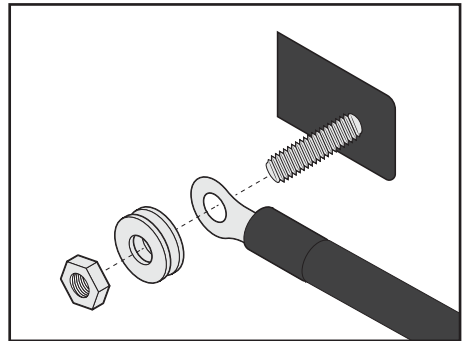
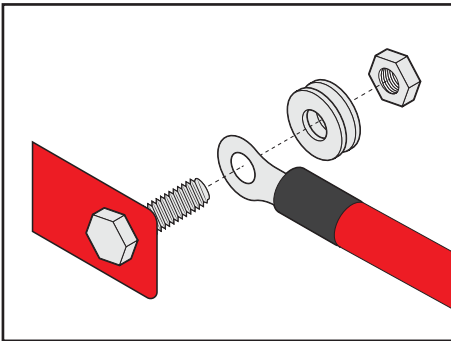

5. Now, fasten the inverter terminal covers back onto the inverter.
6. These cables should then be connected to the battery/DC power source. Fasten them first to the positive terminal, then the negative. Ensure that the positive lead has an appropriately sized fuse placed close to the battery.

BASIC SETUP DIAGRAM

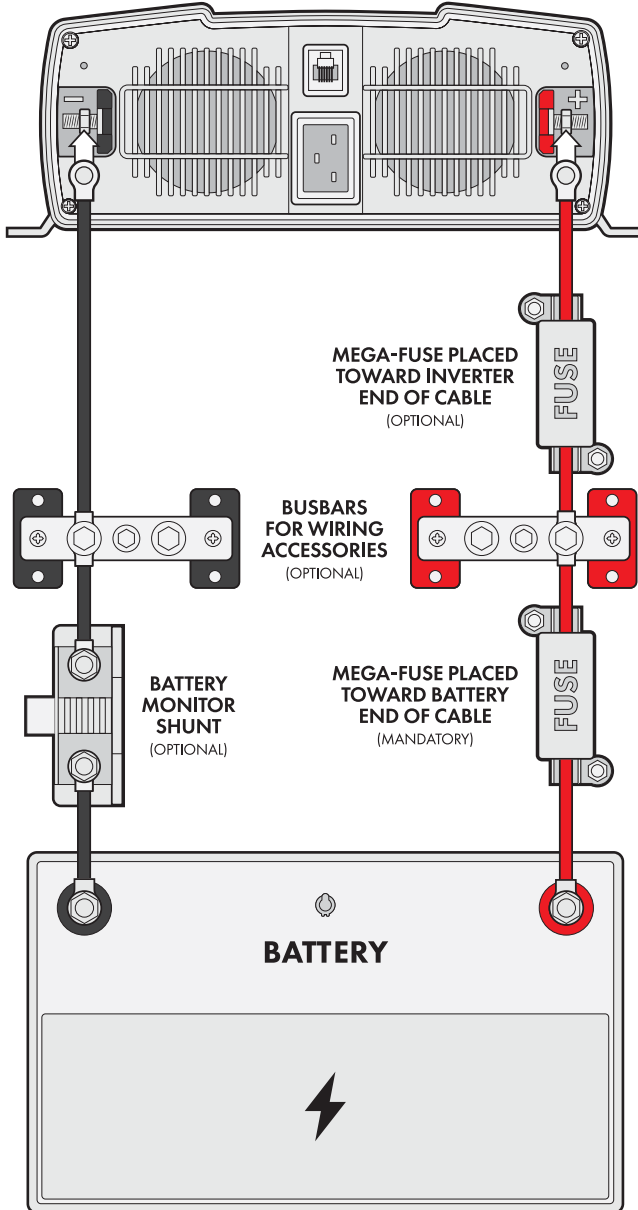

WHAT IS AN AC TRANSFER SWITCH?

This function allows the inverter to automatically switch from running via 12V to AC/mains power. Particularly useful for conserving your batteries, it is used in scenarios when you have decided to run your setup from a generator or from a powered site at a caravan park. The feature is enabled as soon as it detects an incoming AC current, switching the inverter from 12V in less than 30 milliseconds.

This section outlines how to wire up the inverter to enable to AC transfer switch function.

Before wiring the inverter into your system, ensure the inverter switch is on the OFF position and nothing is plugged into the AC outputs.

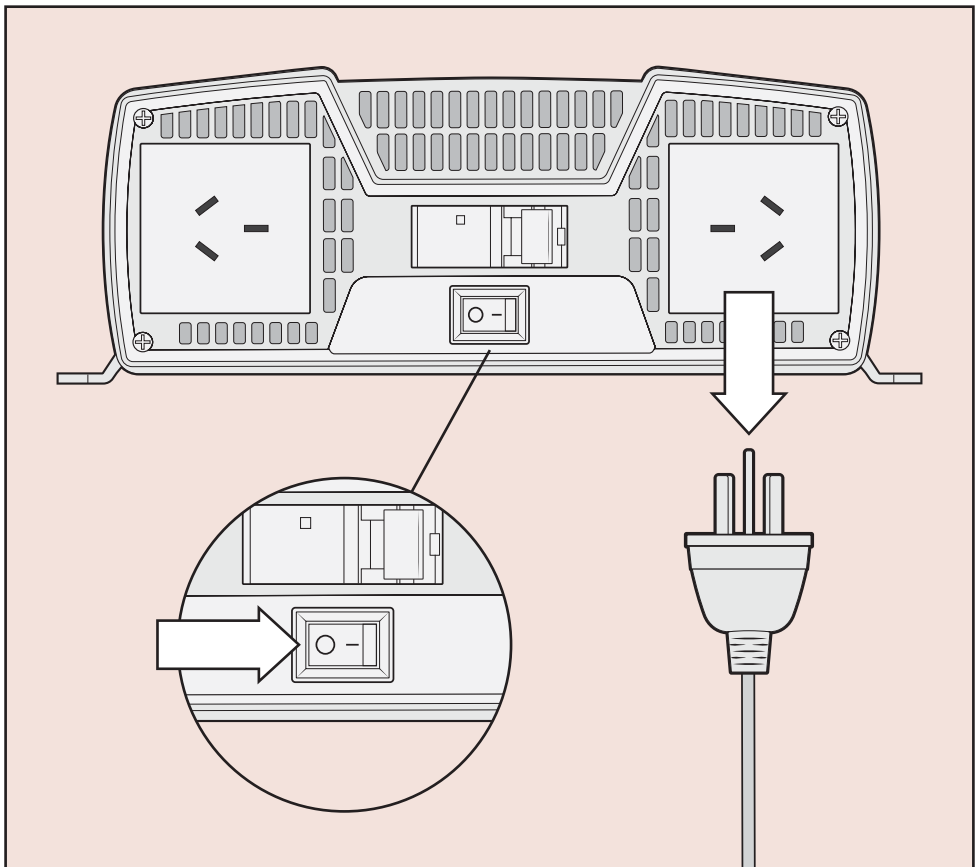

THIS PROCESS MUST BE COMPLETED BEFORE ANY INSTALLATION

AC INPUT INSTALLATION

The following cables are required prior to connecting the AC input. Note: These are not included in your kit.

AC INPUT CABLE	HKPINVAC1000	HKPINVAC2000	HKPINVAC3000
INPUT END	IEC-C13	IEC-C19	
MAINS END	TYPE I		

IEC-C13

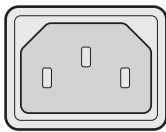

IEC-C19

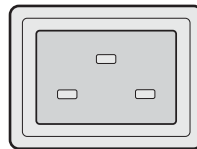

TYPE I

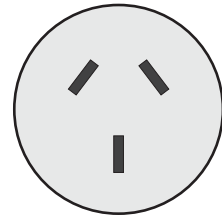

To connect the inverter to AC power simply plug the IEC plug into the inverter’s onboard AC input, then plug the three-pin plug into an AC socket outlet/power point. The inverter is designed to automatically run off AC power when available.



SETUPS THAT INCLUDE HARD-WIRED AC PORTS REQUIRE A LICENCED PROFESSIONAL TO INSTALL THE INVERTER.

REMOTE CONTROL INSTALLATION

The remote allows the inverter to be operated from an alternate location. This is ideal in installs where the inverter may not be easily accessible. The remote is designed to be flush-mounted onto a suitable surface, such as a canopy wall.

1. Locate a space you would like the inverter remote control to be positioned, preferably an interior space free from moisture.
2. Consult the below mounting diagram for reference. You can mark the mounting holes and corners of the cutout with a pin or centre punch.

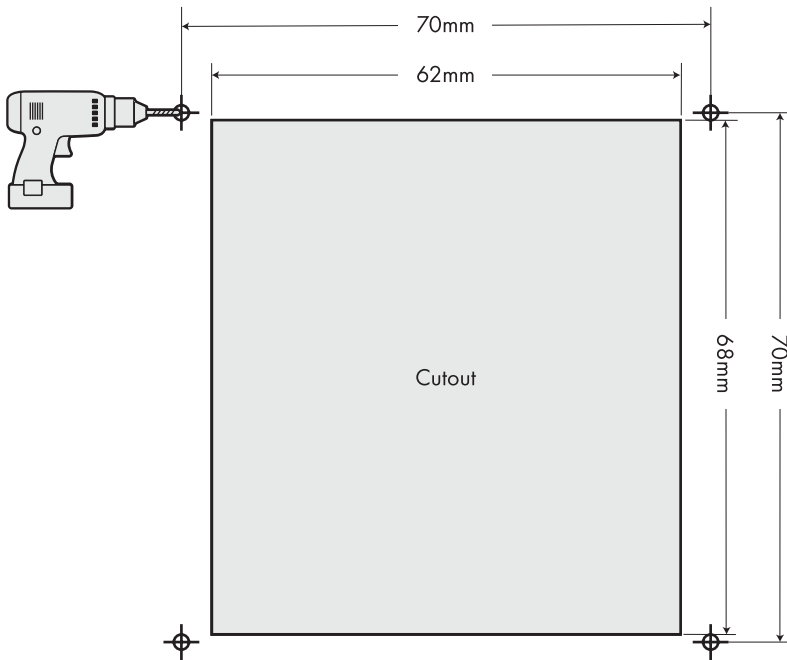

3. Drill 2mm holes in the marked mounting points (or simply leave the points marked) and cut a hole in the surface of the mounting location according to the above diagram.
4. Remove the faceplate of the remote by pulling on the small recess along one of the outer edges (varies depending on model).
5. Place the remote into the hole that you cut and use M3 screws (self-tapping screws if the holes were not pre-drilled) to fasten the remote in place.
6. Re-attach the remote faceplate and plug the RJ 11 connector into the corresponding port on the inverter.

OPERATING THE INVERTER

After wiring up the input side, the inverter is now ready to run your 240V appliances. Before operating the inverter, make sure that the appliance/s you intend on running have a total/cumulative wattage that is below the inverter's rated wattage. Below outlines the process of running your appliances off the inverter.

1. If running the inverter from 12V, make sure the battery has enough charge to be able to run it. If running from AC input, make sure it has been connected securely.
2. Make sure the RCD switch is in the correct position. Do not operate if it has been tripped - consult an electrician.
3. Plug the appliance into the unit's AC output socket.
4. Turn the inverter on, and make sure the mains AC supply is on if you are running the inverter that way.
5. Switch the appliance on.

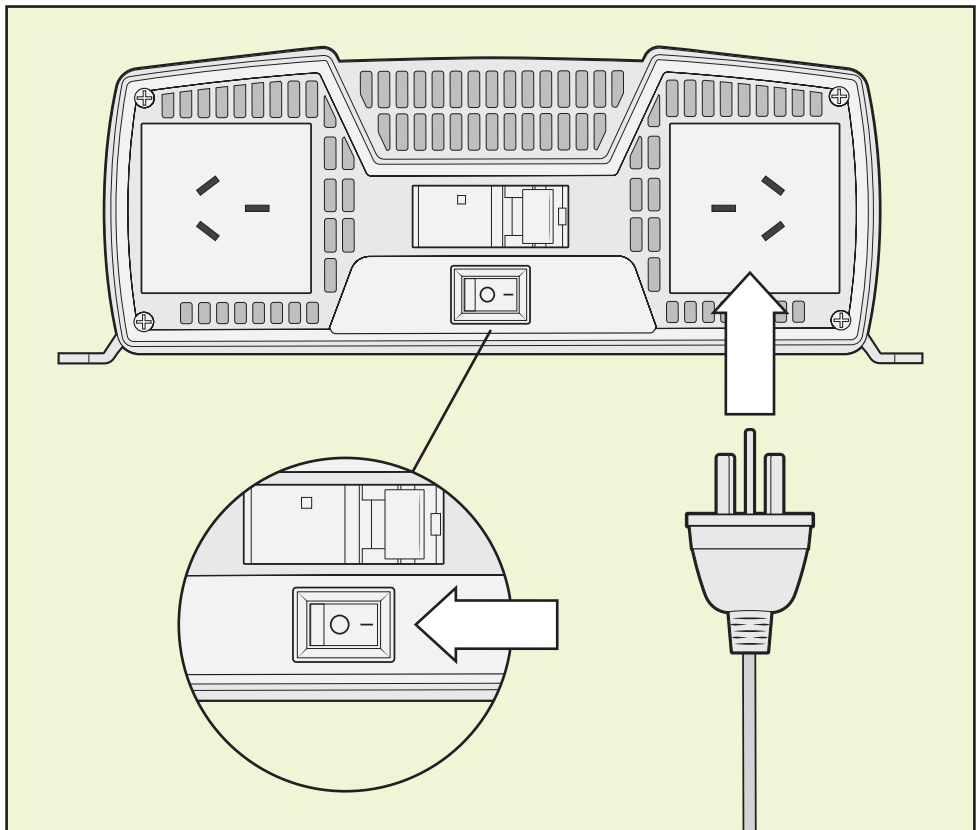

AC OUTPUT OVERVIEW

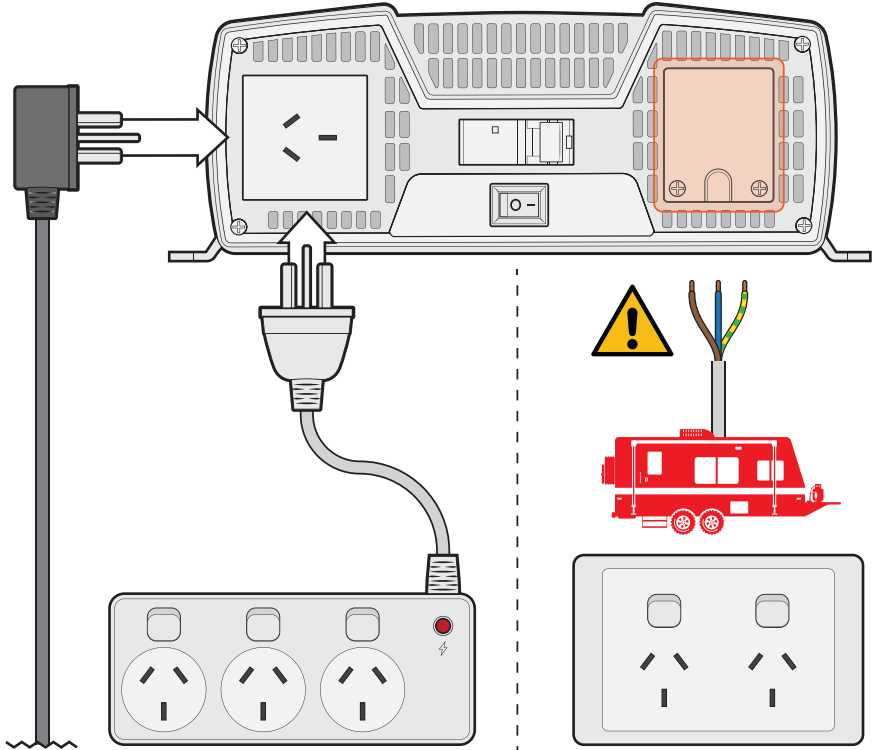

STANDARD AC INPUT

Each inverter contains standard Type I 240V sockets for appliances.

You can plug the appliance directly into the inverter, or use a powerboard to power multiple appliances at the same time. Please note that you can only plug multiple devices in with wattages that are below the respective inverter's capability (example below).

100W + 200W + 500W = 800W power draw

ANGER: ELECTRICAL SHOCK HAZARD. ONLY LICENCED ELECTRICIANS ARE PERMITTED TO CONNECT LOADS TO THE HARD WIRE TERMINAL BLOCK.

HWPINAC3000

The **3000W** inverter model is equipped with a hard wire terminal block for use within a caravan or other permanent fitment situation.

BATTERY RUN TIMES

The following chart gives an estimate as to how long Hardkor lithium batteries can sustain different wattages from our inverters. The times in the chart have been put together with consideration to an 80% Depth of Discharge (DOD), and the inverters performing at an 89% efficiency rate.

NOTE: These figures are to be used as guides only.

	100AH	105AH	135AH	200AH	210AH	240AH
100W	513	538	692	1025	1077	1230
250W	205	215	277	410	431	492
500W	103	108	138	205	215	246
1000W	51	54	69	103	108	123
1500W	N.R	36	N.R	68	72	82
2000W	N.R	27	N.R	51	54	62
2500W	N.R	N.R	N.R	N.R	43	N.R
3000W	A larger continuous discharge rate is required. Consider a parallel battery configuration.					

N.R = Not recommended - continuous discharge rate is too low.

Units of table data are in minutes.

The same can be worked out for other batteries using the formula below:

Run time = (Battery Ah x DOD% x Battery Voltage) / Wattage draw x (Inverter efficiency rate)% x 60

Before using the above formula, consider the continuous discharge rate of your battery. Also, take into account the draw from your other appliances running from the battery.

ECO MODE - 2000W/3000W ONLY

Eco mode allows the inverter to run more conservatively, with a draw of <0.2A, when the inverter doesn't have a detected output. When the function is not enabled the 2000W inverter will draw up to 1.3A when on standby with the 3000W drawing up to 1.6A.

To enable this function, press the "ECO" button on the inverter. This will light up the eco indicator on the top left-hand corner of the screen. With eco mode enabled, appliances can often take up to three seconds to start up.

The function will allow current through the inverter when it detects more than 50W and stop output when there's less than 50W.

SCREEN NAVIGATION

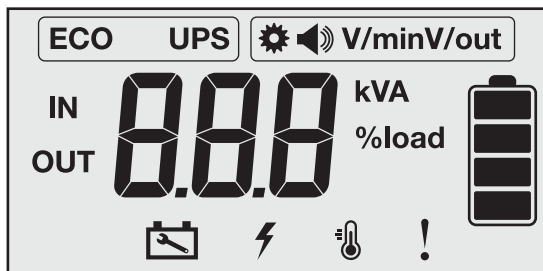

MAIN SCREEN VIA DC INPUT

The main screen will display key information about the inverter's inputs and outputs. When using with 12V, you have access to the input voltage, output voltage (V), outgoing current (A), outgoing volt-amps (kVa), and the inverter's load capacity (%load). You can cycle through these using the ">" button to progress through each item, and the "<" to go back.

MAIN SCREEN VIA AC INPUT

When running via an AC input, the screen will show the Uninterrupted Power Source (UPS) indicator. The main figure will then display input voltage, which is the voltage from the DC source, and the output voltage. You can cycle between the two with the "<" and ">" buttons.

SETTINGS







The settings menu allows you to toggle the alarm, change the low voltage alarm figure, and set the standard output voltage.

To navigate to the settings menu, hold down the "SET" button for three seconds until the gear icon appears.

The first item that will appear when you are in the settings menu is the speaker icon which is the alarm. The "<" button will turn the alarm off, whilst the ">" button will turn it on.

Press the "SET" button again to navigate to the V/min item. This will allow you to change the low-voltage alarm which, when on, will sound when the battery input is at/below the set value. You can set the alarm to 10.5V, 11V, or 11.5V by using the "<" to lower the value or ">" to increase the figure.

The last item is V/out which is the standard voltage output of the inverter. In most circumstances, this should stay at 240V. Press the "SET" button again to navigate from V/min to use V/out then the "<" button to lower the value or ">" to increase it. The value will change in increments of 5 from 220V to 240V.

ICON	FUNCTION / DESCRIPTION
ECO	This indicates the inverter is running on ECO mode.
UPS	This indicates the inverter is running via an Uninterrupted Power Supply (UPS). This will turn on when running from an AC input.
	This indicates that you are in the settings menu.
	Once in the settings menu, this indicates that you are changing the alarm on or off.
V/min	Once in the settings menu, this indicates that you are changing the low voltage alarm figure.
V/out	Once in the settings menu, this indicates that you are changing the standard output voltage.
IN	When present, this indicates that the main figure is related to the input.
OUT	When present, indicates that the main figure is related to the output.
888	This is the main figure display. It is used to change settings and display useful information about the inverter's inputs and outputs.
V	This indicates that the main figure shown is the voltage being input/output.
A	This indicates the main figure shown is the current amp draw of the inverter. Not visible when UPS is present.
kVA	This indicates the main figure shown is the volt-amperes (kVA) that the inverter is outputting. Not visible when UPS is present.
%load	This indicates the main figure shown is the load of the inverter, stated as a percentage. Not visible when UPS is present.
	A basic state-of-charge level based on your battery's voltage.
	This will come on when the battery is inputting either a voltage that is either too high or too low.
	This will come on when the AC output has a short circuit fault.
	This will come on when the temperature is too high.
	This will come on when there is an overload fault.





FAULT CODES - 1000W

Our 1000W inverters will display a flashing light on its fault LED when one of its protections is triggered. This LED is found on the output end of the 1000W inverter. If your unit encounters a fault or error, make sure to inspect the system, noting the conditions, input source, and output wattage.

FLASH	FAULT	SOLUTION
1 FLASH /5 SECS	Input over/under voltage. Occurs when input voltage is outside the range of <10.5 and >15.5V.	The inverter will make a beeping sound and stop outputting. It'll then take one minute to detect a voltage. If the inverter receives a compatible input voltage it will recover automatically: When threshold voltage >12.0V: The inverter will automatically recover from under-voltage protection. When threshold voltage <14.5V: The inverter will automatically recover from over-voltage protection.
2 FLASH /5 SECS	AC output short-circuit.	The inverter will make a beeping sound and stop outputting. Please unplug and check your appliance, then restart your inverter manually.
3 FLASH /5 SECS	Over-temperature. Occurs when ambient temperature rises above 60°C. Usually due to poor ventilation or fan malfunction.	The inverter will make a beeping sound and stop outputting. Turn the inverter off and unplug your appliance. Let the inverter cool down - the inverter needs to be cooled below 60°C. Once at a suitable temperature, turn the inverter back on using the switch.
4 FLASH /5 SECS	Over-load.	The inverter will make a beeping sound and stop outputting after a few seconds. Unplug your appliance/s, and note the wattage of them. Do not operate the appliance/s if they reach a wattage that is over the inverter's rated output. The inverter will then need to be manually restarted using the switch.
1 FLASH /1 SECS	Internal fault.	Use the on/off switch to restart the inverter. Repeat several times until the unit starts up. If the inverter still fails to work normally, consult that Hardkorr technical team for repairs/replacement. Do not attempt to disassemble the unit.
RCD TRIPPED	Current leakage.	Call the Hardkorr technical team and consult a licenced electrician before resetting the RCD switch or operating the inverter.

FAULT CODES - 2000W/3000W

Our 2000W and 3000W inverters will display an error code on the screen when one of its protections is triggered. If your unit encounters a fault or error, make sure to inspect the system, noting the conditions, input source, and output wattage.

CODE	FAULT	SOLUTION
<p>F01</p> 	<p>Input over/under voltage. Occurs when input voltage is outside the range of <math><10.5</math> and <math>>15.5</math>V.</p>	<p>The inverter will make a beeping sound and stop outputting. It'll then take one minute to detect a voltage. If the inverter receives a compatible input voltage it will recover automatically:</p> <p>When threshold voltage >12.0V: The inverter will automatically recover from under-voltage protection.</p> <p>When threshold voltage <14.5V: The inverter will automatically recover from over-voltage protection.</p>
<p>F02</p> 	<p>AC output short-circuit.</p>	<p>The inverter will make a beeping sound and stop outputting. Please unplug and check your appliance, then restart your inverter manually.</p>
<p>F03</p> 	<p>Over-temperature. Occurs when ambient temperature rises above 60°C. Usually due to poor ventilation or fan malfunction.</p>	<p>The inverter will make a beeping sound and stop outputting. Turn the inverter off and unplug your appliance. Let the inverter cool down - the inverter needs to be cooled below 60°C. Once at a suitable temperature, turn the inverter back on using the switch.</p>
<p>F04</p> 	<p>Over-load.</p>	<p>The inverter will make a beeping sound and stop outputting after a few seconds. Unplug your appliance/s, and note the wattage of them. Do not operate the appliance/s if they reach a wattage that is over the inverter's rated output. The inverter will then need to be manually restarted using the switch.</p>
<p>F05</p>	<p>Internal fault.</p>	<p>Use the on/off switch to restart the inverter. Repeat several times until the unit starts up. If the inverter still fails to work normally, consult that Hardkorr technical team for repairs/replacement.</p> <p>Do not attempt to disassemble the unit.</p>
<p>RCD TRIPPED</p>	<p>Current leakage.</p>	<p>Call the Hardkorr technical team and consult a licenced electrician before resetting the RCD switch or operating the inverter.</p>



Our goods come with guarantees that cannot be excluded under the Australian Consumer Law. You are entitled to a replacement or refund for a major failure and compensation for any other reasonably foreseeable loss or damage. You are also entitled to have the goods repaired or replaced if the goods fail to be of acceptable quality and the failure does not amount to a major failure.

Hardkorr warrants that this product will be free from defects in material and workmanship for two years. The warranty commences on the date of purchase by the original purchaser, and is not transferable. To access the benefits of this warranty, you must retain your proof of purchase and follow any other direction we reasonably give you (e.g. completing and returning your warranty card if applicable).

TO BEGIN A WARRANTY CLAIM:

If you believe your Hardkorr product is defective, it must be returned to Hardkorr for inspection by our warranty claims department.

1. You must have a Return Authorization (RA) number. To get your RA number, please complete the form found on our website and wait for the warranty team to contact you.
2. Once you have an RA number, you must arrange for the product must be shipped at your own expense back to Hardkorr (keep your receipt). The address for shipment will be provided when we issue your RA number.
3. Please be sure that your RA number is clearly marked on the outside of the packaging used for shipping.

Completing the steps as mentioned will ensure a faster process of your claim, so that Hardkorr can get your product back to you as soon as possible.

Once we receive your returned product, our technicians will inspect it. We will then notify you of the outcome of your claim.

If we accept your warranty claim, we will either repair, replace or refund the goods at our discretion. We will also reimburse you for the shipping costs you incurred in sending the goods back to us. Any products that we choose to replace or refund become the property of Hardkorr.

If we do not accept your claim, we will advise you of the reason and hold your product for collection. You will need to arrange and pay for the product to be shipped back to you. If your product is not collected within 30 days of your warranty claim being finalised, we may destroy it.

Your warranty is voided if we (at our sole discretion) determine that there is evidence of one or more of the following:

Negligence: Improper installation, improper or extreme use, use that contravenes this instruction manual, etc.

Abuse: Road hazards, Damage beyond the limits of "normal wear and tear."

Unauthorized Repair: Repair service performed by an unauthorised service centre.

Disassembly: Any attempt to open, tamper with or otherwise compromise the integrity of the product.

Consequential damage: damage to this product caused by the failure of another component of the vehicle or device in which this product is installed.

Additionally, in the case of battery products: the following will void your warranty:

Incorrect charger: The use of a battery charger that is not suitable for lithium batteries i.e. does not have a lithium battery charge profile.

Under bonnet use: Using this battery under the bonnet of a vehicle.

Overcharge/over-discharge: Charging or discharging your battery at a rate higher than those stipulated in the Specifications table of this instruction manual.

Water ingress: your battery is not designed to be installed in an area that is subject to water ingress.

It is reasonable to expect that over its service life the capacity of your battery will reduce. Natural capacity decrease, which we define as a decrease in capacity of less than 10% per year of ownership, is not covered by this warranty. All batteries are tested using our in-house equipment and if we decline your claim for capacity decrease we will provide you with a copy of the test report.

Exterior Finish: Hardkorr uses the highest quality materials available, but depending on location, environment and exposure, the colour of exterior surfaces can fade. We will not approve any warranty claims that relate to fade.

DISCONTINUED ITEMS

Discontinued items that are still under warranty will be reviewed by Hardkorr. If a discontinued item is covered under warranty it may be replaced by an equivalent or superior item. If an equivalent item is not available Hardkorr will determine terms of resolution on a case-by-case basis.

LIFE
WITHOUT
LIMITS

HARDKORR™

   @HARDKORRAU

WWW.HARDKORR.COM